

Article datasheet

Countersunk Screw ISO2009 M2.5x4 PA-66 Natural UL94-V2 Slotted

Article-No.: 001.46.206



Color:	Natural
DIN/ISO:	DIN963 / ISO2009
Drive Type:	Slotted
Flammability Class:	UL94-V2
Head Diameter [mm]:	4.7
Head Height [mm]:	1.5
Head Shape:	Countersunk Head
Length [mm]:	4
Material:	PA 6.6
Material Group:	Plastic
Thread Size:	M2.5
Weight:	0.04g
Conformities:	



Image may be similar

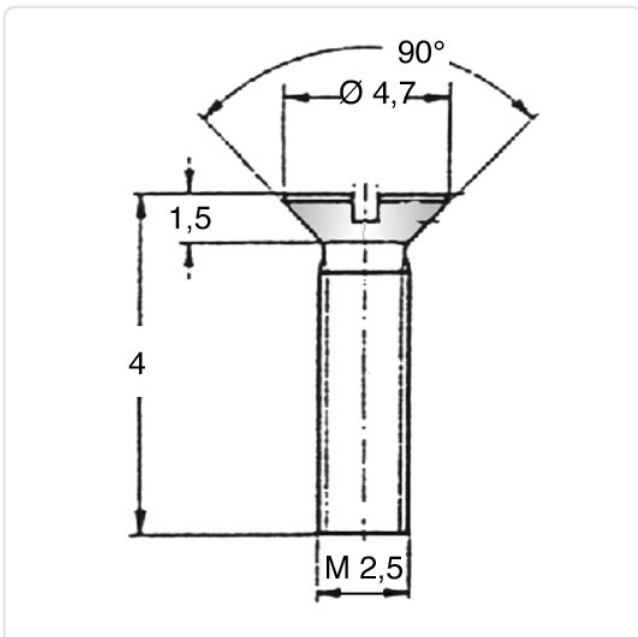

You can find all
information on the web on
our article detail page

Would you like individual advice?

We look forward to your email to products@ettinger.de.

Subject to change and errors.