

Article datasheet

## Long Nut M6 DIN6334 Galvanized Steel AF 10x18 / M6

Article-No.: 002.20.061

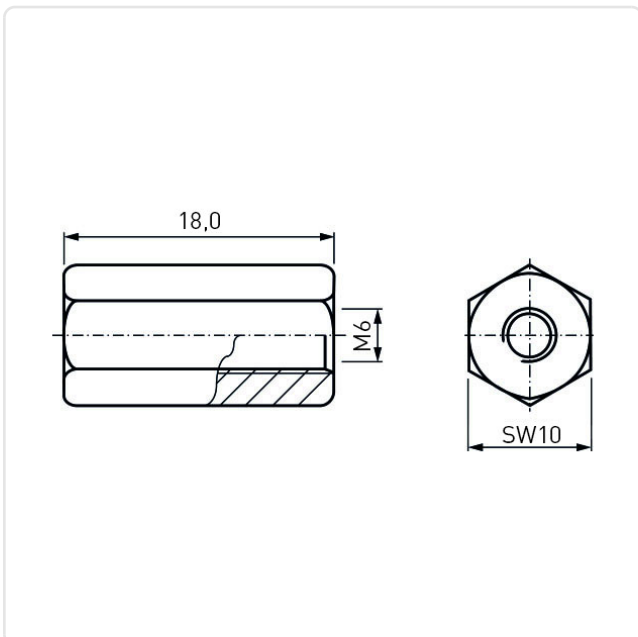

Image may be similar

DIN/ISO: DIN6334  
Finish: Galvanized, Blue, 5 µm, A2K  
Length [mm]: 18  
Material: Steel 11SMnPb30(+C)  
Material Group: Steel  
Thread Size: M6  
Weight: 8.16g  
Conformities:



You can find all  
information on the web on  
our article detail page



Would you like individual advice?

We look forward to your email to [products@ettinger.de](mailto:products@ettinger.de).

Subject to change and errors.