

Article datasheet

## Hexagonal Screw DIN933/ISO4017 M5x10 A2 Plain Stainless Steel Hexagon

Article-No.: 001.13.542



Image may be similar

Actuator Size:	Hexagon Hex8
DIN/ISO:	DIN933 / ISO4017
Drive Type:	Hexagon
Finish:	Plain
Head Diameter [mm]:	8
Head Height [mm]:	3.5
Head Shape:	Hexagon Head
Length [mm]:	10
Material:	Stainless Steel AISI 304 / A2
Material Group:	Stainless Steel
Thread Size:	M5
Weight:	2.4g
Conformities:	

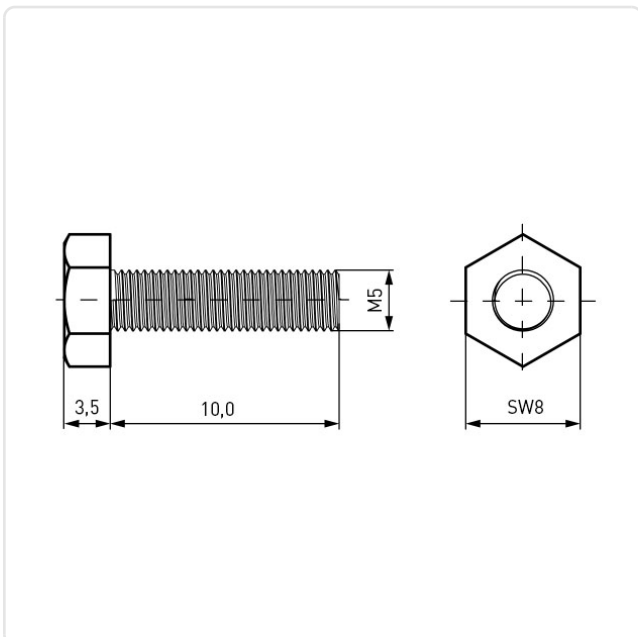

You can find all  
information on the web on  
our article detail page

Would you like individual advice?

We look forward to your email to [products@ettinger.de](mailto:products@ettinger.de).

Subject to change and errors.