

Article datasheet

Serrated Washer DIN6798 A Ø4.3/8.0 x 0.5 A4 Plain Stainless Steel

Article-No.: 003.54.049



Image may be similar

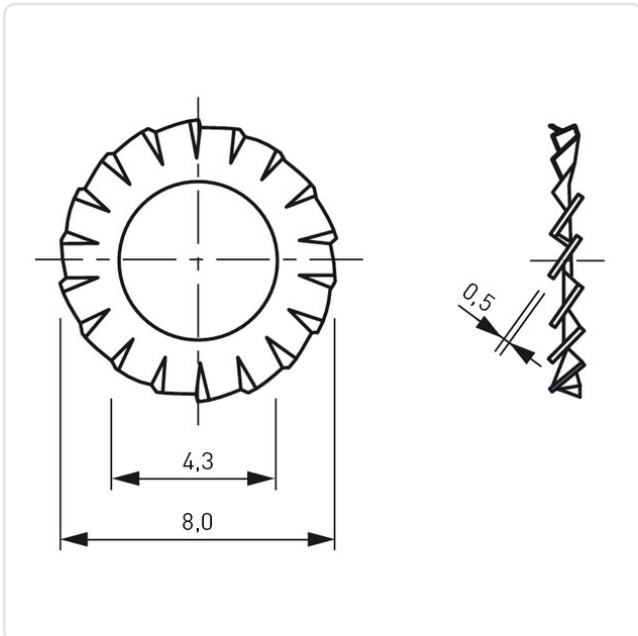

DIN/ISO: DIN6798A
Finish: Plain
For Thread Size: M4
Inner Diameter [mm]: 4.3
Material: Stainless Steel A4 / AISI 316
Material Group: Stainless Steel
Outer Diameter [mm]: 8
Weight: 0.11g
Conformities:



You can find all information on the web on our article detail page

Would you like individual advice?

We look forward to your email to products@ettinger.de.

Subject to change and errors.