

Article datasheet

Pan Head Screw ISO7045 M4x8 A4 STEEL C/R Self-Sealing SEELSKREW®

Article-No.: 001.57.439

Manufacturer: APM Hexseal

Manufacturer article-no.: RM4X8 SEELSKREW



Image may be similar

Actuator Size:	Phillips PH2
DIN/ISO:	DIN7985 / ISO7045
Drive Type:	Cross Recess / Phillips-H
Finish:	Passivated, Clear
Head Diameter [mm]:	8
Head Height [mm]:	3.1
Head Shape:	Flat Head
Length [mm]:	8
Material:	Stainless Steel A4 / AISI 316
Material Group:	Stainless Steel
O-Ring Material:	Silicone
Temperature Range [°C]:	-106°C to +260°C
Thread Size:	M4
Weight:	1.4g
Conformities:	

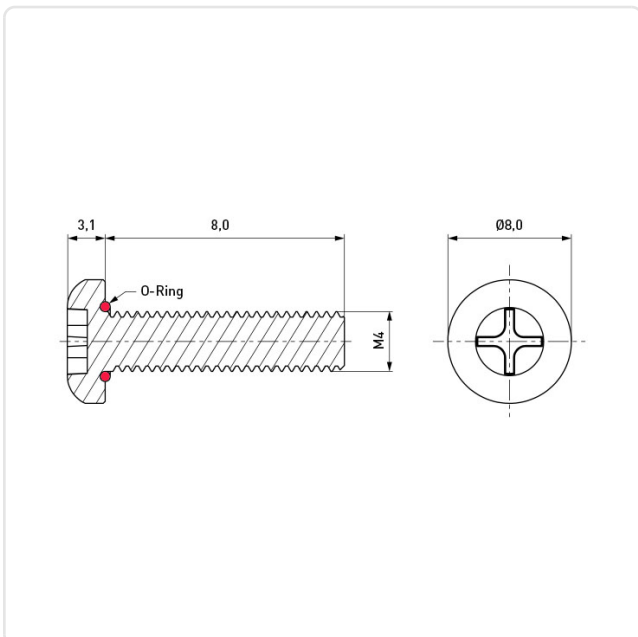

You can find all information on the web on our article detail page

Would you like individual advice?

We look forward to your email to products@ettinger.de.

Subject to change and errors.