

Article datasheet

PCB Support 8.0 | $\varnothing 4.0$ | $\varnothing 4.0$ Polyamide 6.6 natural

Article-No.: 006.27.086

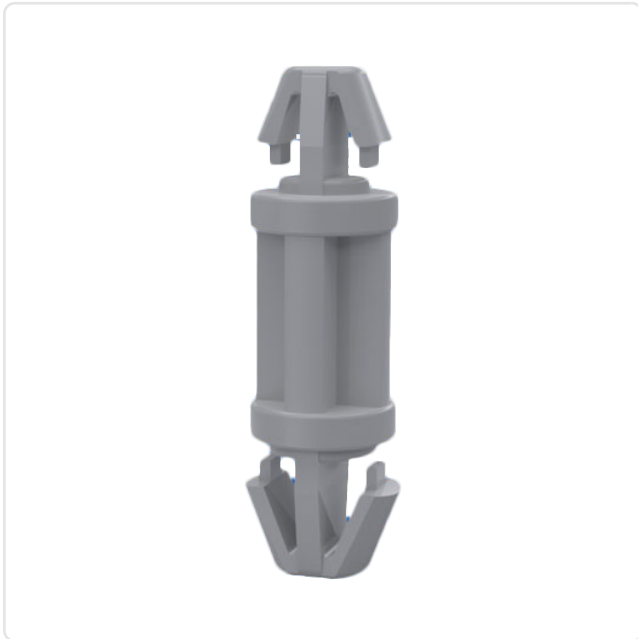

Image may be similar

Color: Natural
Flammability Class: UL94-V2
Length [mm]: 8
Material: PA 6.6
PCB Hole \varnothing [mm]: 4
PCB Thickness [mm]: 1,6
Panel Hole \varnothing [mm]: 4
Panel Thickness [mm]: 1,6
Weight: 0.24g
Conformities:



You can find all information on the web on our article detail page

Would you like individual advice?

We look forward to your email to products@ettinger.de.

Subject to change and errors.

