

Article datasheet

Insulated Standoff PA-Brass F/F $\varnothing 6.5 \times 30$ | Thread M3x6 / M3x6

Article-No.: 005.48.330



Image may be similar

AF / OD [mm]: 6.5
Flammability Class: UL94-HB
Length [mm]: 30
Material: PA 6.6
Material Group: Plastic
Profile: Round
Thread 1 Length [mm]: 6
Thread 1 Size: M3
Thread 2 Length [mm]: 6
Thread 2 Size: M3
Thread Insert Material: Brass
Weight: 1.51g
Conformities:

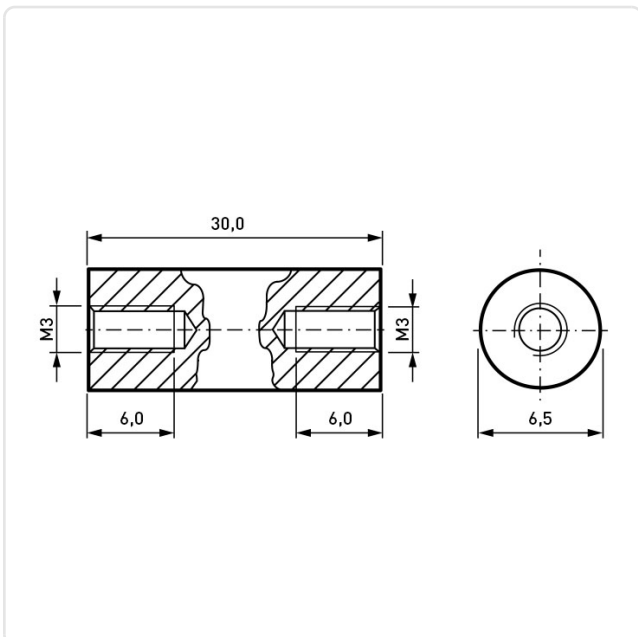

You can find all
information on the web on
our article detail page

Would you like individual advice?

We look forward to your email to products@ettinger.de.

Subject to change and errors.