

Article datasheet

Lock Nut DIN985/ISO10511 M4 A2 Plain Stainless Steel

Article-No.: 002.08.504

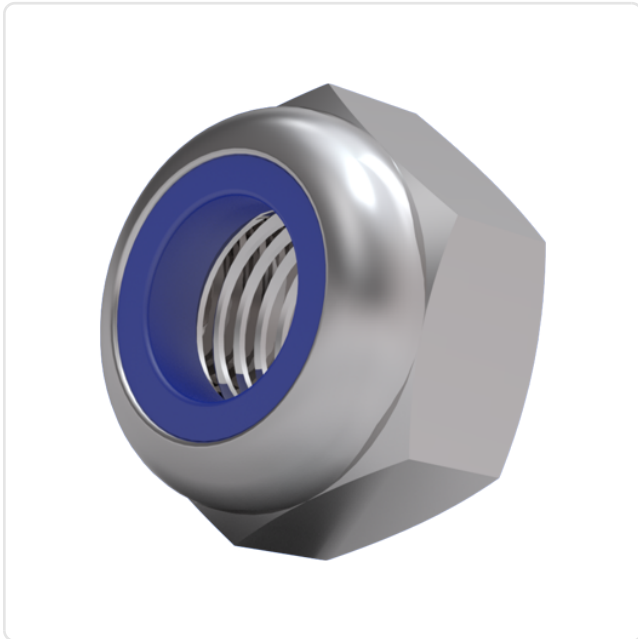
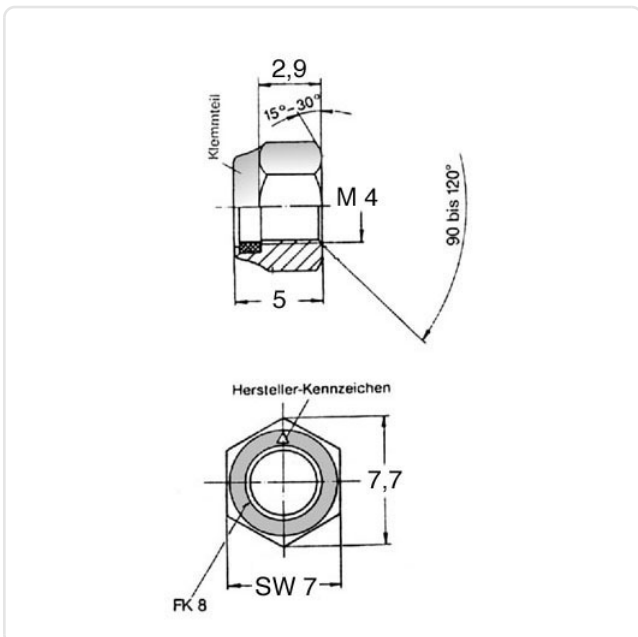

Image may be similar

AF / OD [mm]: 7
DIN/ISO: DIN985 / ISO10511
Finish: Plain
Height [mm]: 5
Material: Stainless Steel AISI 304 / A2
Material Group: Stainless Steel
Thread Size: M4
Weight: 0.85g
Conformities:



You can find all information on the web on our article detail page



Would you like individual advice?

We look forward to your email to products@ettinger.de.

Subject to change and errors.