

Article datasheet

Thread Forming Screw DIN7500C M6x16 Galv. Steel Case Hardened Pozi Pan Head

Article-No.: 001.38.661

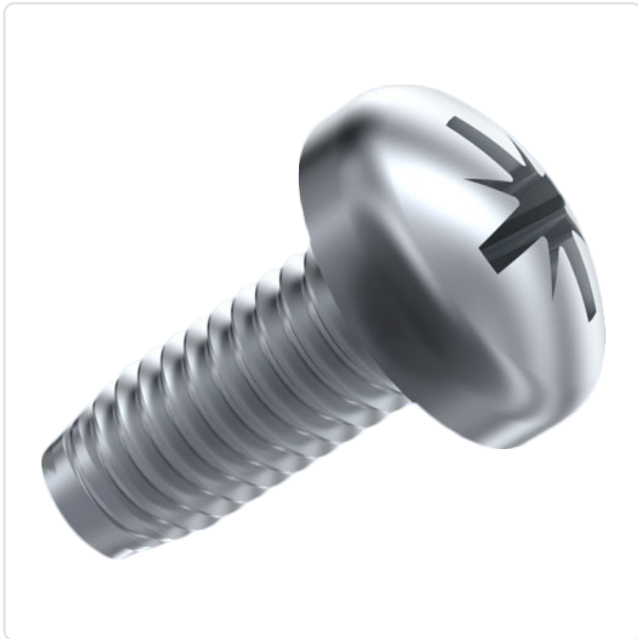

Actuator Size:	Pozidriv PZ3
DIN/ISO:	DIN7500-C
Drive Type:	Cross Recess / Pozidriv-Z
Finish:	Galvanized, Blue, 5 µm, A2K
Head Diameter [mm]:	12
Head Height [mm]:	4.6
Head Shape:	Pan Head
Length [mm]:	16
Material:	Case-Hardened Steel
Material Group:	Steel
Thread Size:	M6
Thread Type:	Metric
Conformities:	



Image may be similar

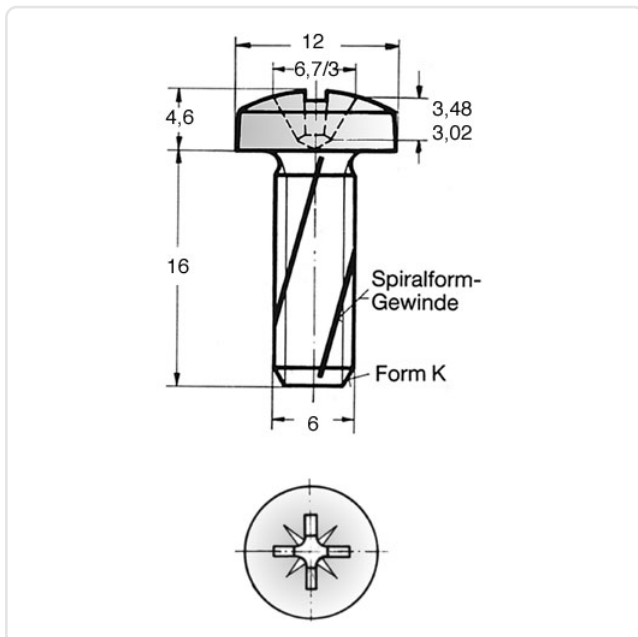

You can find all information on the web on our article detail page

Would you like individual advice?

We look forward to your email to products@ettinger.de.

Subject to change and errors.