

Article datasheet

Harness Rap 25-100, PE, natural, 25m roll

Article-No.: 014.75.351

Manufacturer: SES-Sterling

Manufacturer article-no.: 0819 0023 001



Image may be similar

Bundle Diameter [mm]: 25,0-100,0

Color: Natural

Flammability Class: UL94-V2

Material: Polyethlene

Model: Spiral Cable Wrap

Reel length [m]: 25

Weight: 1880g

Conformities:



You can find all
information on the web on
our article detail page

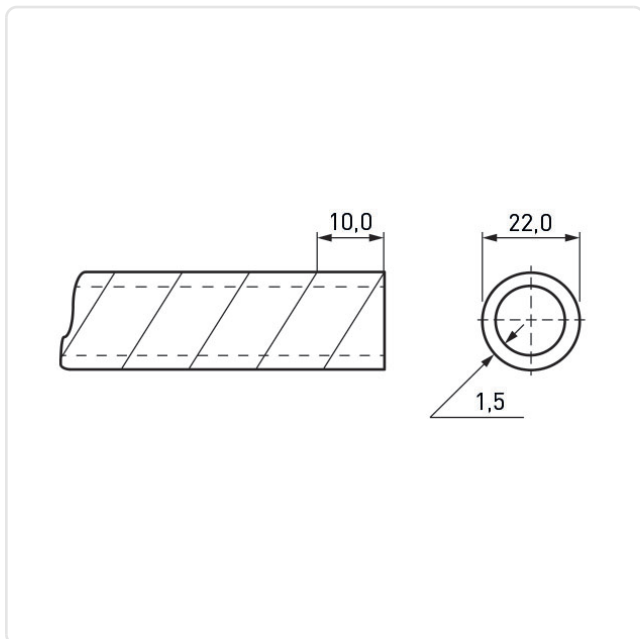

Would you like individual advice?

We look forward to your email to products@ettinger.de.

Subject to change and errors.