

Article datasheet

Conical Spring Washer $\varnothing 4.3/7.2 \times 0.4$ Galvanized Spring Steel

Article-No.: 003.24.941

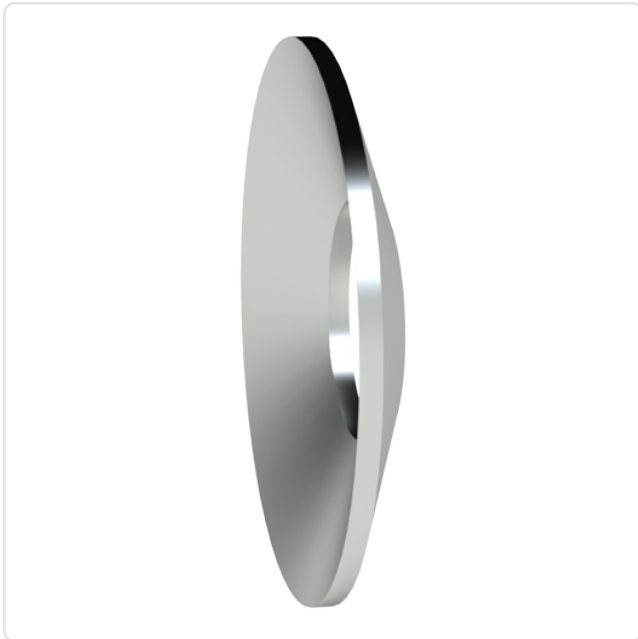
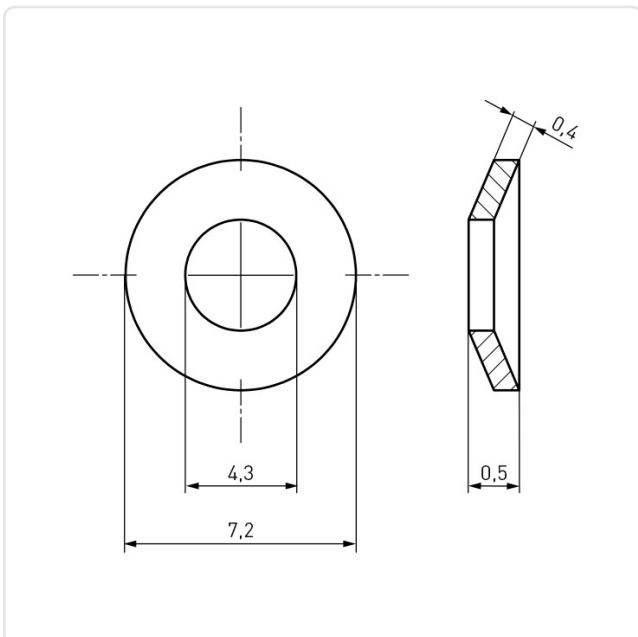

Image may be similar

Finish: Galvanized, Blue, 5 μm , A2K
For Thread Size: M4
Height [mm]: 0.4
Inner Diameter [mm]: 4.3
Material: Spring Steel
Material Group: Steel
Outer Diameter [mm]: 7.2
Weight: 0.07g
Conformities:



You can find all information on the web on our article detail page



Would you like individual advice?

We look forward to your email to products@ettinger.de.

Subject to change and errors.