

Article datasheet

Countersunk Screw ISO2009 M3x5 PA-66 Natural UL94-V2 Slotted

Article-No.: 001.46.316



Image may be similar

Color:	Natural
DIN/ISO:	DIN963 / ISO2009
Drive Type:	Slotted
Flammability Class:	UL94-V2
Head Diameter [mm]:	5.6
Head Height [mm]:	1.65
Head Shape:	Countersunk Head
Length [mm]:	5
Material:	PA 6.6
Material Group:	Plastic
Thread Size:	M3
Weight:	0.05g
Conformities:	

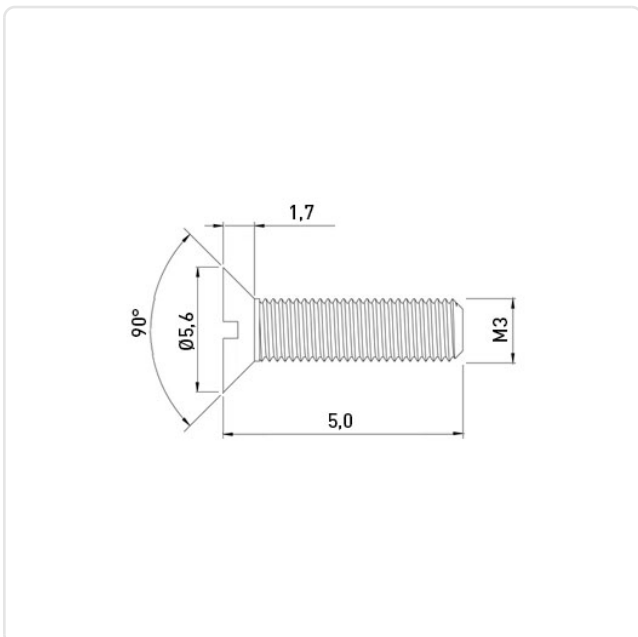

You can find all
information on the web on
our article detail page

Would you like individual advice?

We look forward to your email to products@ettinger.de.

Subject to change and errors.