

Article datasheet

## PCB Support 19.1 | $\varnothing$ 4.0 Polyamide 6.6 natural

Article-No.: 006.07.156

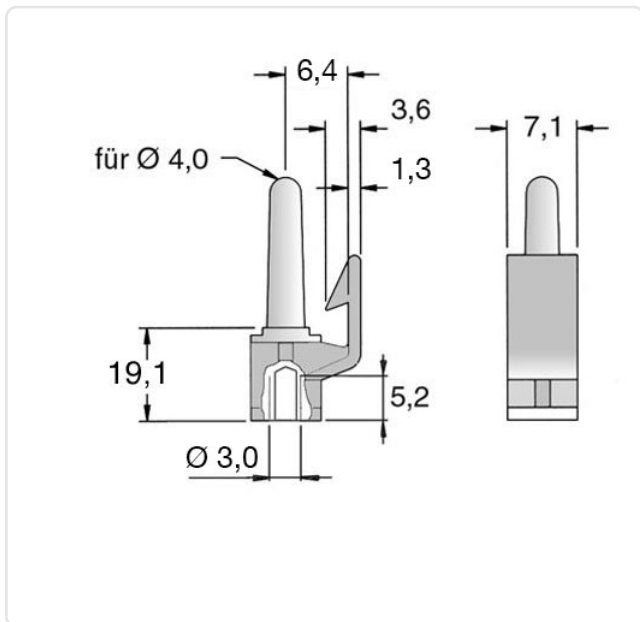

Image may be similar

Color: Natural  
Flammability Class: UL94-V2  
Length [mm]: 19.1  
Material: PA 6.6 UL94 V-2 E 70062 / RMS01  
PCB Hole  $\varnothing$  [mm]: 4  
PCB Thickness [mm]: 1,6  
Panel Hole  $\varnothing$  [mm]: 3  
Weight: 0.82g  
Conformities:



You can find all information on the web on our article detail page



Would you like individual advice?

We look forward to your email to [products@ettinger.de](mailto:products@ettinger.de).

Subject to change and errors.