

Article datasheet

## Countersunk Screw ISO7047 M2.5x8 Galvanized Steel 4.8 Cross Recessed

Article-No.: 001.12.237



Image may be similar

Actuator Size:	Phillips PH1
DIN/ISO:	DIN966 / ISO7047
Drive Type:	Cross Recess / Phillips-H
Finish:	Galvanized, Blue, 5 µm, A2K
Head Diameter [mm]:	4.7
Head Height [mm]:	1.5
Head Shape:	Countersunk Head
Length [mm]:	8
Material:	Steel 4.8
Material Group:	Steel
Thread Size:	M2.5
Weight:	0.35g
Conformities:	

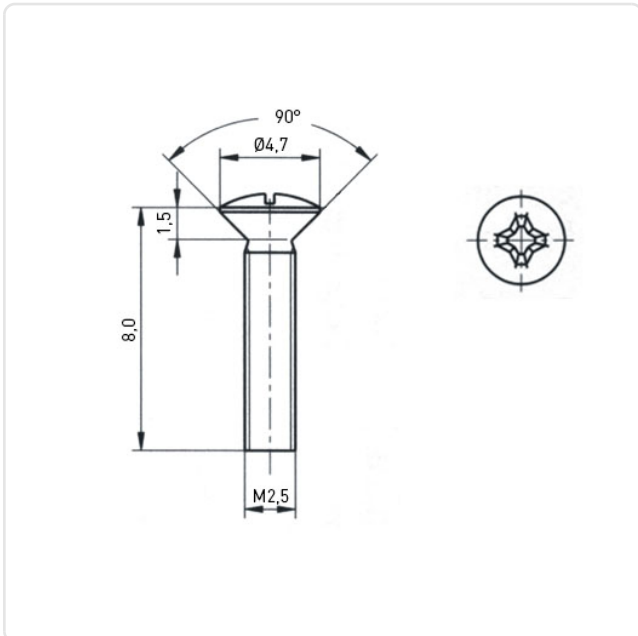

You can find all  
information on the web on  
our article detail page

Would you like individual advice?

We look forward to your email to [products@ettinger.de](mailto:products@ettinger.de).

Subject to change and errors.