

Article datasheet

Hexagonal Screw DIN933/ISO4017 M5x16 Galvanized Steel 8.8 Hexagon

Article-No.: 001.13.561

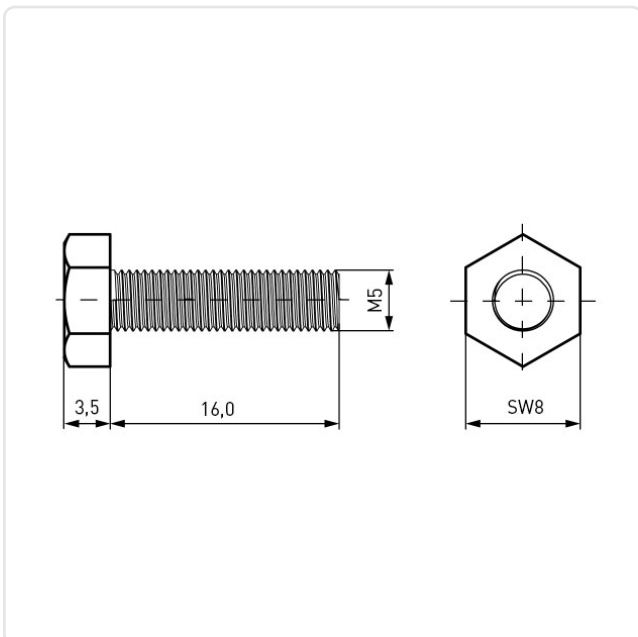

Image may be similar

Actuator Size:	Hexagon Hex8
DIN/ISO:	DIN933 / ISO4017
Drive Type:	Hexagon
Finish:	Galvanized, Blue, 5 µm, A2K
Head Diameter [mm]:	8
Head Height [mm]:	3.5
Head Shape:	Hexagon Head
Length [mm]:	16
Material:	Steel 8.8
Material Group:	Steel
Thread Size:	M5
Weight:	3.29g
Conformities:	



You can find all
information on the web on
our article detail page



Would you like individual advice?

We look forward to your email to products@ettinger.de.

Subject to change and errors.