

Article datasheet

SEMS Screw ISO7045 PH M3x6 Galv. Steel 4.8 Clamping Washer

Article-No.: 081.58.329



Actuator Size:	Phillips PH1
Combination:	Clamping Washer
DIN/ISO:	DIN7985 / ISO7045
Drive Type:	Cross Recess / Slotted
Finish:	Galvanized, Blue, 5 µm, A2K
Head Diameter [mm]:	6
Head Height [mm]:	2.4
Head Shape:	Pan Head
Length [mm]:	6
Material:	Steel 4.8
Thread Size:	M3
Weight:	0.93g
Conformities:	



Image may be similar

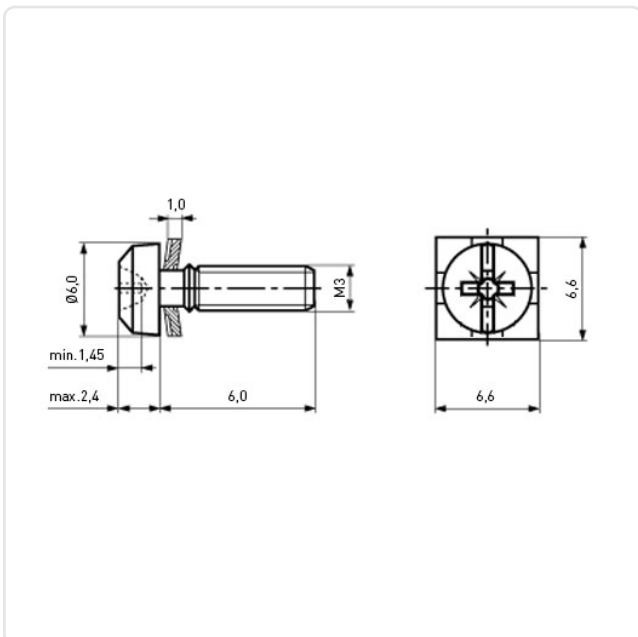

You can find all
information on the web on
our article detail page

Would you like individual advice?
We look forward to your email to products@ettinger.de.

Subject to change and errors.