

Article datasheet

Cage Nut M6 Panel Thk. Range 1.2-1.6mm A2 Plain Stainless Steel / Galv. Steel

Article-No.: 002.56.219

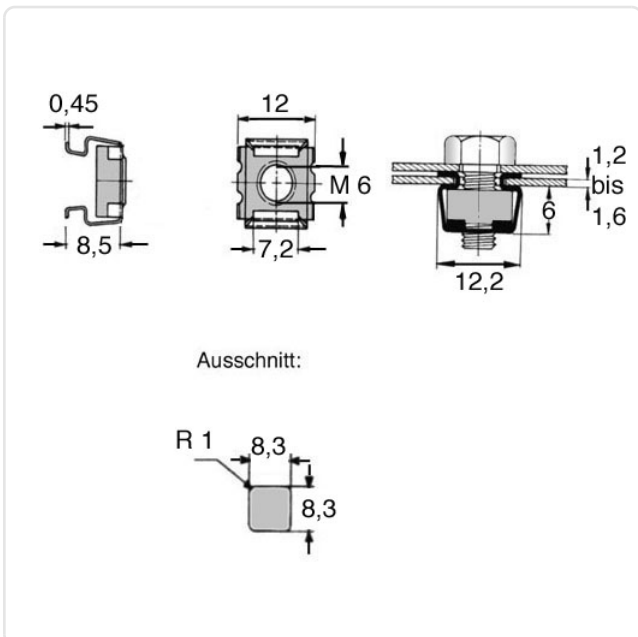

Image may be similar

Finish:	Plain Cage / Galvanized Nut
Height [mm]:	8.5
Material:	Käfig, rostfrei A2 / Mutter vzk
Material Group:	Steel
Panel Cutout [mm]:	8.3x8.3
Panel Thickness Range [mm]:	1,2-1,6
Thread Size:	M6
Weight:	3.31g
Conformities:	



You can find all information on the web on our article detail page



Would you like individual advice?

We look forward to your email to products@ettinger.de.

Subject to change and errors.