

Article datasheet

## Weld Nut DIN928 M8 Plain Steel Square

Article-No.: 002.30.081

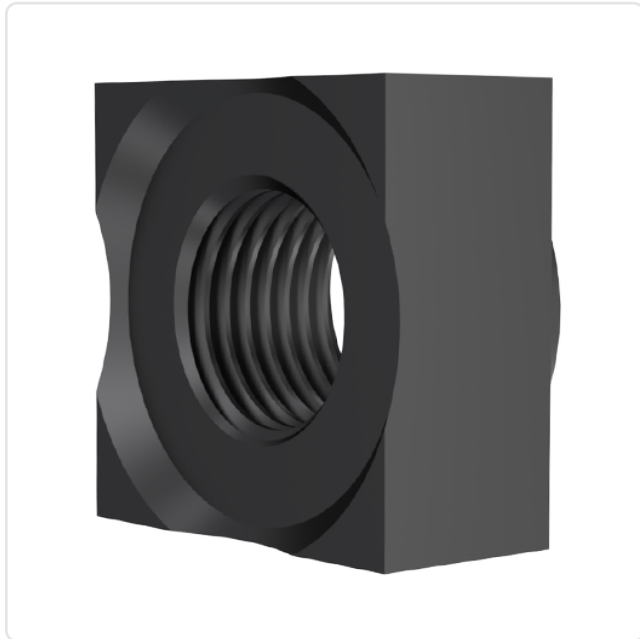
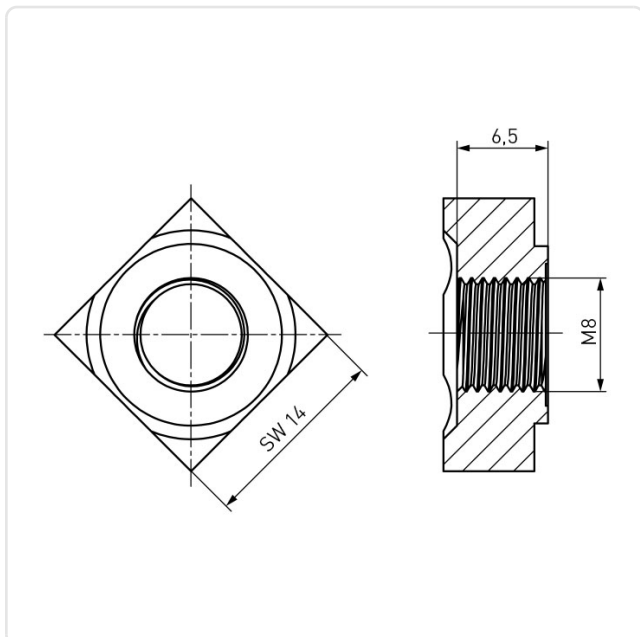

Image may be similar

AF / OD [mm]: 14  
DIN/ISO: DIN928  
Finish: Plain  
Height [mm]: 6.5  
Material: Steel  
Thread Size: M8  
Conformities:



You can find all  
information on the web on  
our article detail page



Would you like individual advice?

We look forward to your email to [products@ettinger.de](mailto:products@ettinger.de).

Subject to change and errors.