

Article datasheet

Hexagonal Screw DIN931/ISO4014 M6x80 Polyamide 6.6 natural Hexagon

Article-No.: 001.42.2010

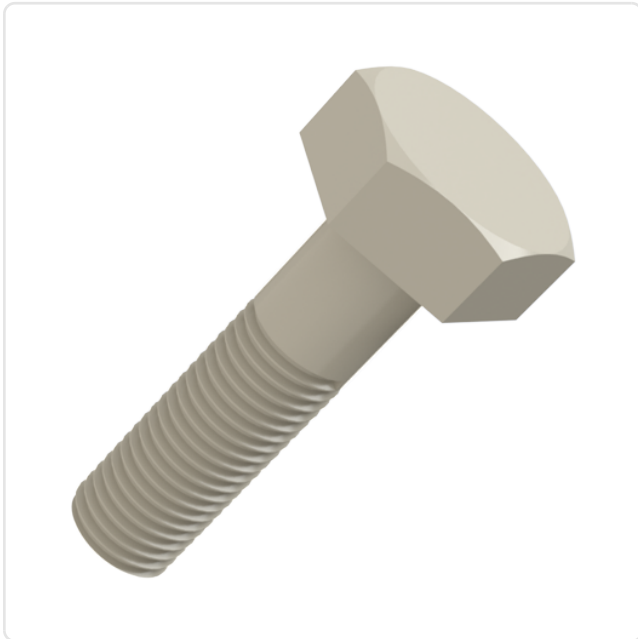
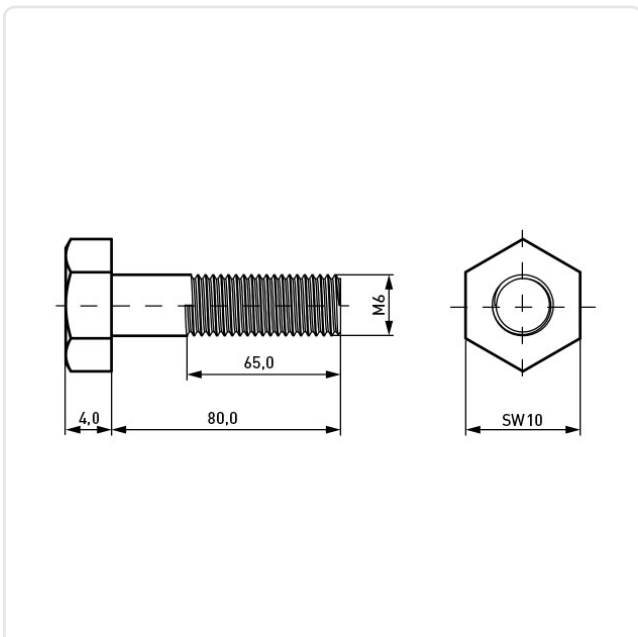

Image may be similar

Actuator Size:	Hexagon Hex10
Color:	Natural
DIN/ISO:	DIN931 / ISO4014
Drive Type:	Hexagon
Head Diameter [mm]:	10
Head Height [mm]:	4
Head Shape:	Hexagon Head
Length [mm]:	80
Material:	PA 6.6
Thread Size:	M6
Weight:	2.664g
Conformities:	



You can find all information on the web on our article detail page



Would you like individual advice?

We look forward to your email to products@ettinger.de.

Subject to change and errors.