

Article datasheet

## Standoff Galvanized Steel M/M AF5.5x5 T1=M3x4 T2=M3x8 w/ UC

Article-No.: 005.21.351

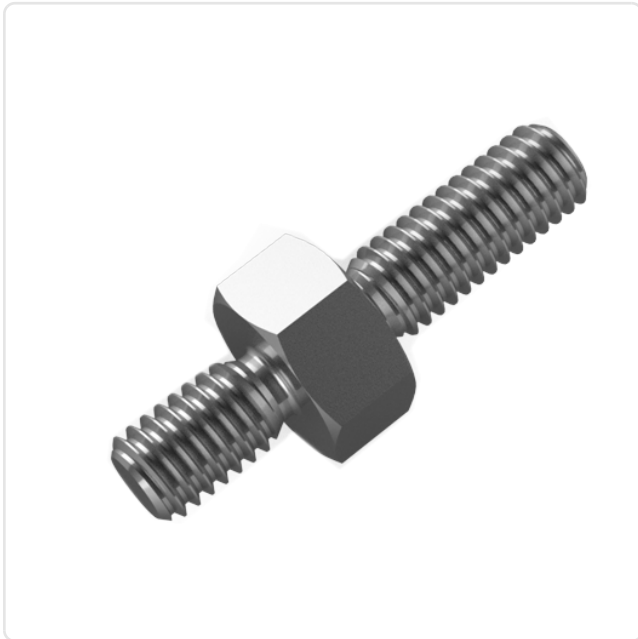
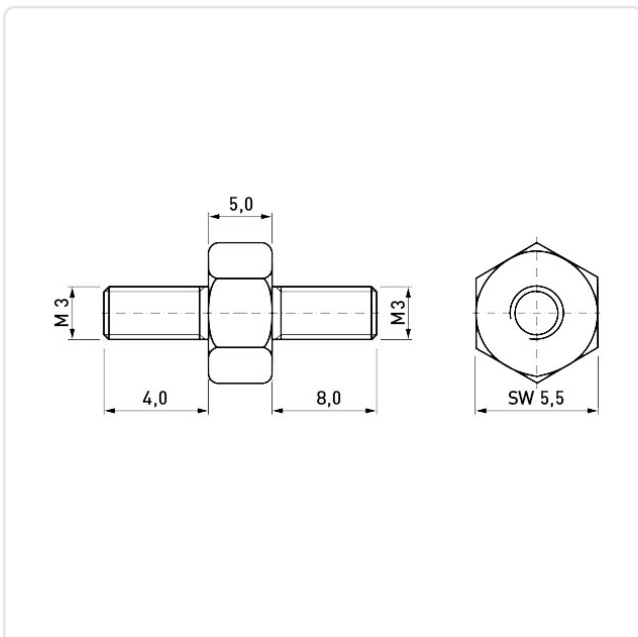

Image may be similar

AF / OD [mm]:	5.5
Finish:	Galvanized, Blue, 5 µm, A2K
Length [mm]:	5
Material:	Steel 11SMnPb30(+C)
Material Group:	Steel
Profile:	Hexagonal
Thread 1 Length [mm]:	4
Thread 1 Size:	M3
Thread 2 Length [mm]:	8
Thread 2 Size:	M3
Undercut:	Yes
Weight:	1.45g
Conformities:	



You can find all  
information on the web on  
our article detail page

Would you like individual advice?

We look forward to your email to [products@ettinger.de](mailto:products@ettinger.de).

Subject to change and errors.