

Article datasheet

## SEMS Screw ISO14583 TX Z4-1 M4x8 Galv. ST 8.8 Washer + Spring Lock Washer

Article-No.: 081.55.436

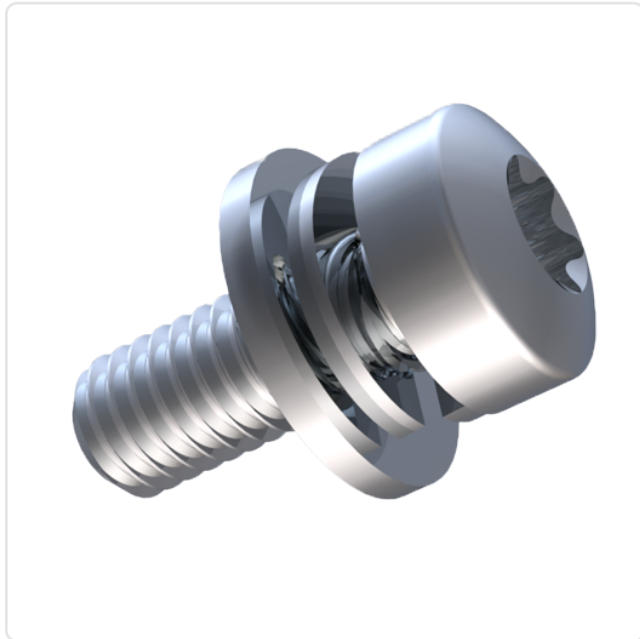
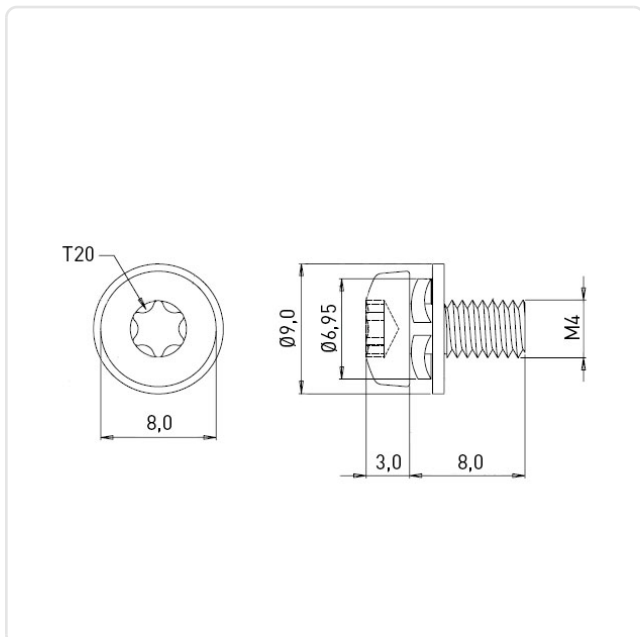

Image may be similar

Actuator Size:	Torx T20
Combination:	Washer DIN6902-1 and Spring Lock Washer DIN6905
DIN/ISO:	ISO14583
Drive Type:	TORX
Finish:	Galvanized, Blue, 5 µm, A2K
Head Diameter [mm]:	8
Head Height [mm]:	3.1
Head Shape:	Pan Head
Length [mm]:	8
Material:	Steel 8.8, lead-free
Thread Size:	M4
Weight:	1.94g
Conformities:	



You can find all information on the web on our article detail page

Would you like individual advice?  
We look forward to your email to [products@ettinger.de](mailto:products@ettinger.de).

Subject to change and errors.