

Article datasheet

PCB Support 15.9 | \varnothing 3.1 Polyamide 6.6 natural

Article-No.: 006.07.546

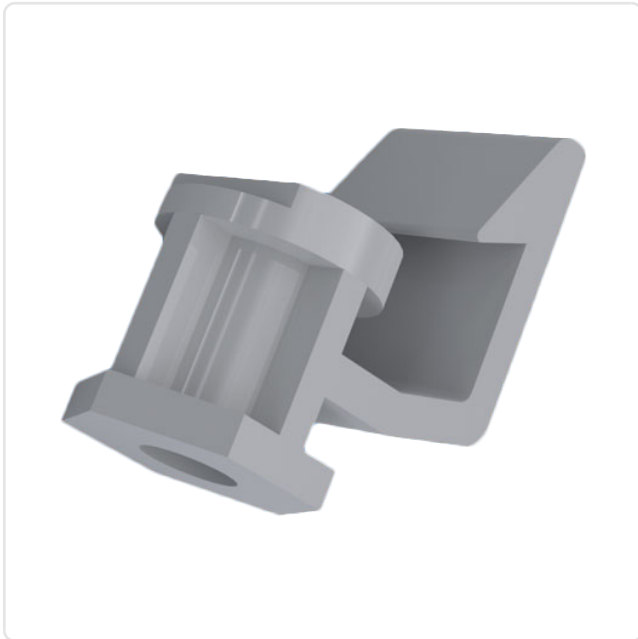

Image may be similar

Color: Natural
Flammability Class: UL94-V2
Length [mm]: 15.9
Material: PA 6.6 UL94 V-2 E 70062 / RMS01
PCB Thickness [mm]: 1,6
Panel Hole \varnothing [mm]: 3.1
Conformities:



You can find all information on the web on our article detail page

Would you like individual advice?

We look forward to your email to products@ettinger.de.

Subject to change and errors.

