

Article datasheet

Standoff Galvanized Steel M/F AF5.5x35 F=M3x7 M=M3x6 w/ Undercut

Article-No.: 005.13.351



AF / OD [mm]:	5.5
Female Thread Length [mm]:	7
Female Thread Size:	M3
Finish:	Galvanized, Blue, 5 µm, A2K
Length [mm]:	35
Male Thread Length [mm]:	6
Male Thread Size:	M3
Material:	Steel AISI 12L13 / 11SMnPb30
Material Group:	Steel
Profile:	Hexagonal
Undercut:	Yes
Weight:	6.9g
Conformities:	



Image may be similar

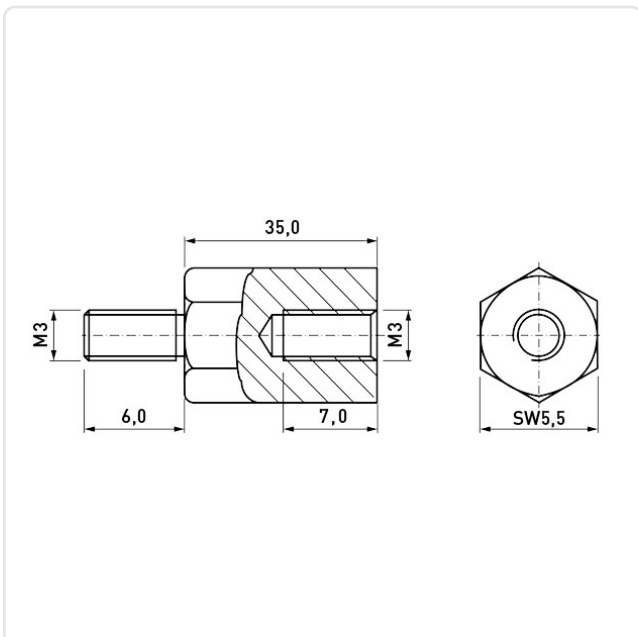

You can find all
information on the web on
our article detail page

Would you like individual advice?

We look forward to your email to products@ettinger.de.

Subject to change and errors.