

Article datasheet

## Combination Nut M5 Galv. Steel Rotatable Contact Washer

Article-No.: 002.09.215

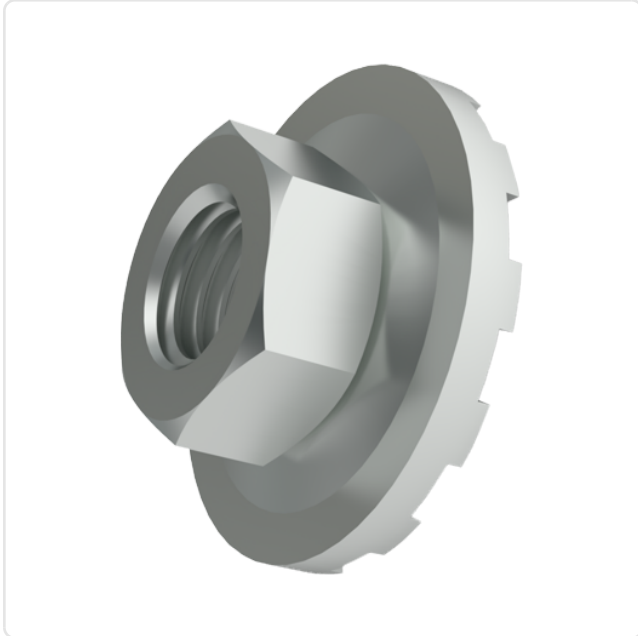
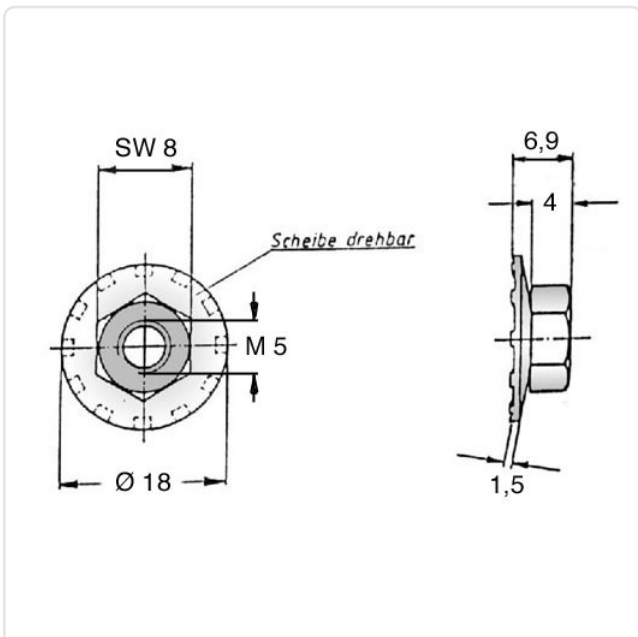

Image may be similar

AF / OD [mm]: 8  
Finish: Galvanized, Blue, 5 µm, A2K  
Height [mm]: 6.9  
Material: Steel  
Material Group: Steel  
Thread Size: M5  
Weight: 3.64g  
Conformities:



You can find all  
information on the web on  
our article detail page



Would you like individual advice?

We look forward to your email to [products@ettinger.de](mailto:products@ettinger.de).

Subject to change and errors.