

Article datasheet

Cage Nut M5 Panel Thk. Range 1.7-2.7mm A2 Plain Stainless Steel / Galv. Steel

Article-No.: 002.55.319

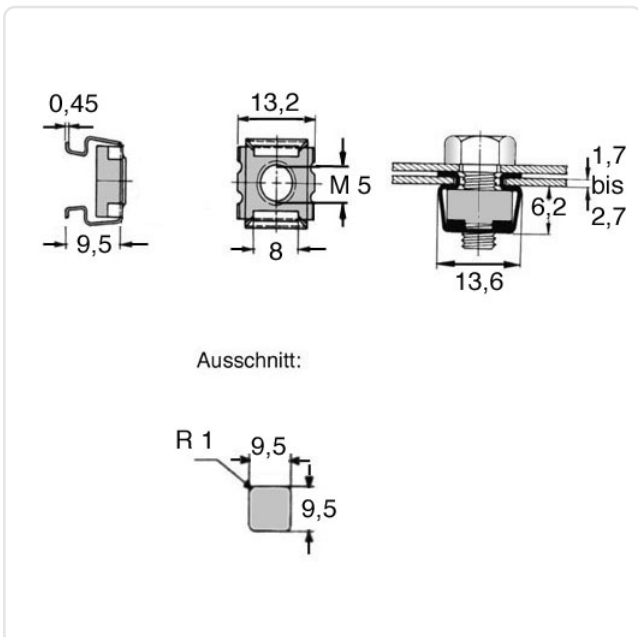

Image may be similar

Finish:	Plain Cage / Galvanized Nut
Height [mm]:	9.5
Material:	Käfig, rostfrei A2 / Mutter vzk
Material Group:	Steel
Panel Cutout [mm]:	9.5x9.5
Panel Thickness Range [mm]:	1,7-2,7
Thread Size:	M5
Weight:	4.77g
Conformities:	



You can find all information on the web on our article detail page



Would you like individual advice?

We look forward to your email to products@ettinger.de.

Subject to change and errors.