

Article datasheet

Dowel Pin ISO2338 Ø5x60 A1 Plain Stainless Steel

Article-No.: 080.10.0560

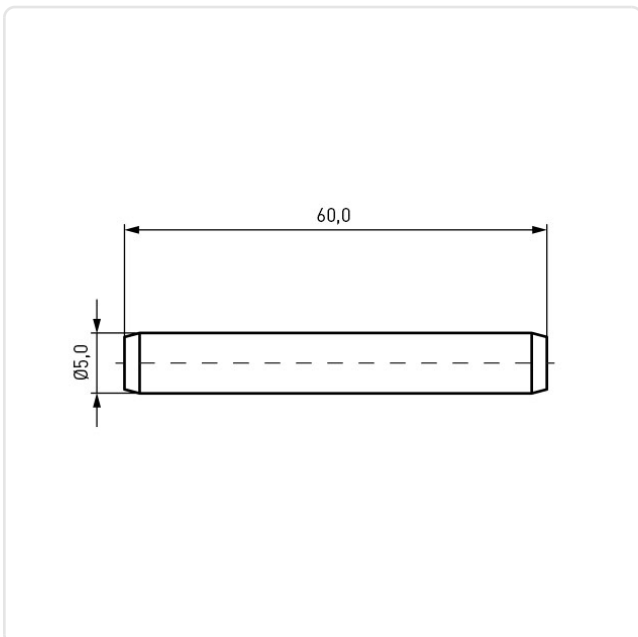

Image may be similar

DIN/ISO: DIN7 / ISO2338
Diameter [mm]: 5
Finish: Plain
Length [mm]: 60
Material: Stainless Steel AISI 303 / A1
Material Group: Stainless Steel
Weight: 9.5g
Conformities:



You can find all
information on the web on
our article detail page



Would you like individual advice?

We look forward to your email to products@ettinger.de.

Subject to change and errors.