

Article datasheet

Long Nut M6 DIN6334 A4 Stainless Steel AF 10x18 / M6

Article-No.: 002.20.069

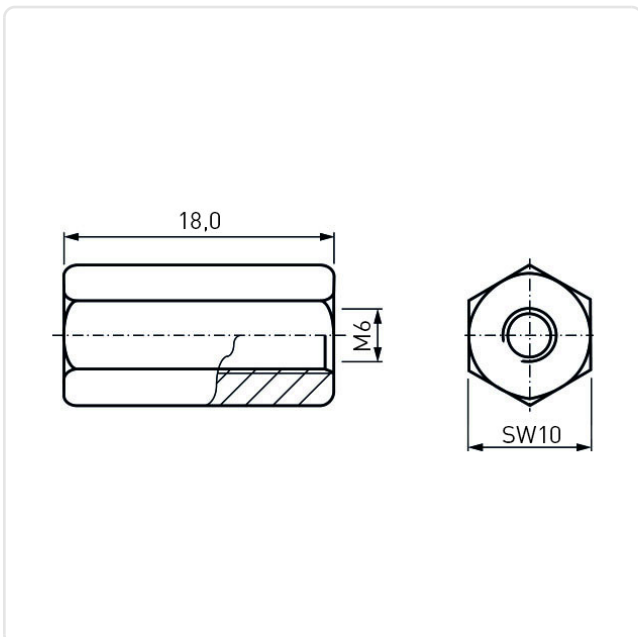

Image may be similar

DIN/ISO: DIN6334
Finish: Plain
Length [mm]: 18
Material: Stainless Steel A4 / AISI 316
Material Group: Stainless Steel
Thread Size: M6
Conformities:



You can find all
information on the web on
our article detail page



Would you like individual advice?

We look forward to your email to products@ettinger.de.

Subject to change and errors.