

Article datasheet

PCB Support 19.1 | $\varnothing 4.8$ | $\varnothing 3.3$ Polyamide 6.6 natural

Article-No.: 006.79.219

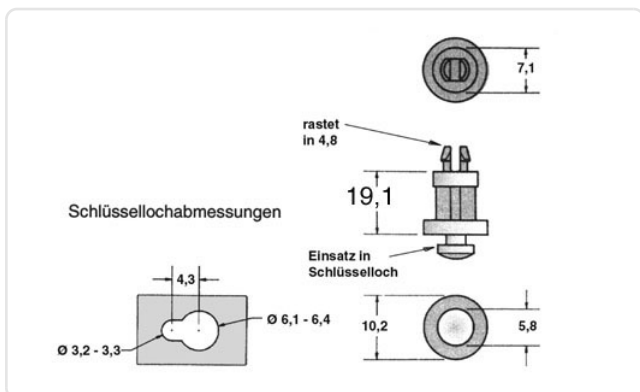

Image may be similar

Color: Natural
Flammability Class: UL94-V2
Length [mm]: 19.1
Material: PA 6.6
PCB Hole \varnothing [mm]: 4.8
PCB Thickness [mm]: 1,6
Panel Hole \varnothing [mm]: 6.4
Panel Thickness [mm]: 1,6
Conformities:



You can find all information on the web on our article detail page



Would you like individual advice?

We look forward to your email to products@ettinger.de.

Subject to change and errors.