

Article datasheet

Flat Head Screw ISO7380-1 M5x12 A2 Plain ST STL Hex Socket Button Head

Article-No.: 001.54.552

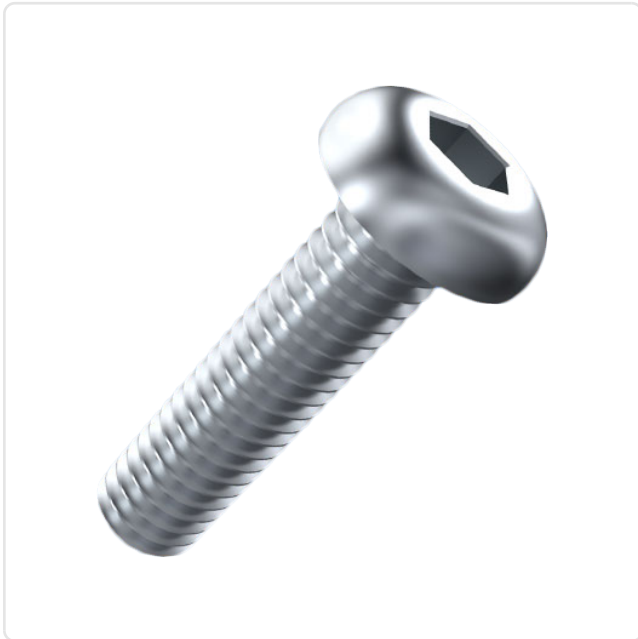
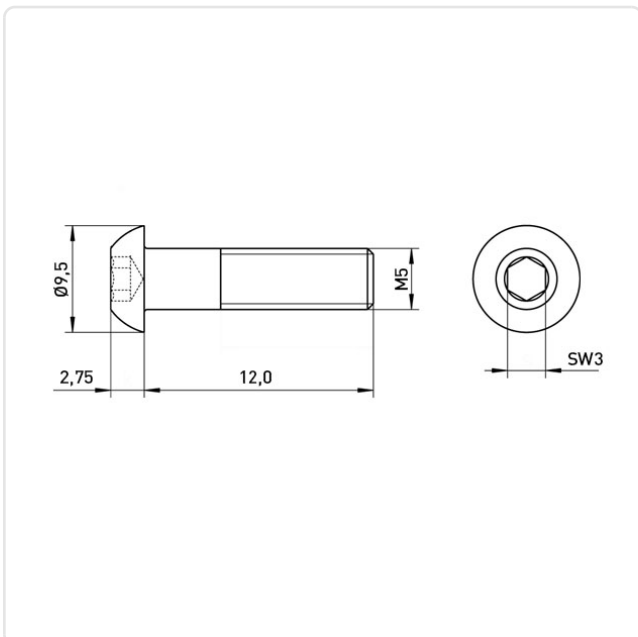

Image may be similar

Actuator Size:	Hexagon Socket Hex3
DIN/ISO:	ISO7380-1
Drive Type:	Hexagon Socket
Finish:	Plain
Head Diameter [mm]:	9.5
Head Height [mm]:	2.75
Head Shape:	Button Head
Length [mm]:	12
Material:	Stainless Steel AISI 304 / A2
Material Group:	Stainless Steel
Thread Size:	M5
Weight:	2.29g
Conformities:	



You can find all
information on the web on
our article detail page



Would you like individual advice?

We look forward to your email to products@ettinger.de.

Subject to change and errors.