

Article datasheet

Countersunk Screw ISO7046 M5x8 Galvanized Steel 4.8 Cross Recessed

Article-No.: 001.12.531



Image may be similar

Actuator Size:	Phillips PH2
DIN/ISO:	DIN965 / ISO7046
Drive Type:	Cross Recess / Phillips-H
Finish:	Galvanized, Blue, 5 µm, A2K
Head Diameter [mm]:	9.2
Head Height [mm]:	2.5
Head Shape:	Countersunk Head
Length [mm]:	8
Material:	Steel 4.8
Material Group:	Steel
Thread Size:	M5
Weight:	1.42g
Conformities:	

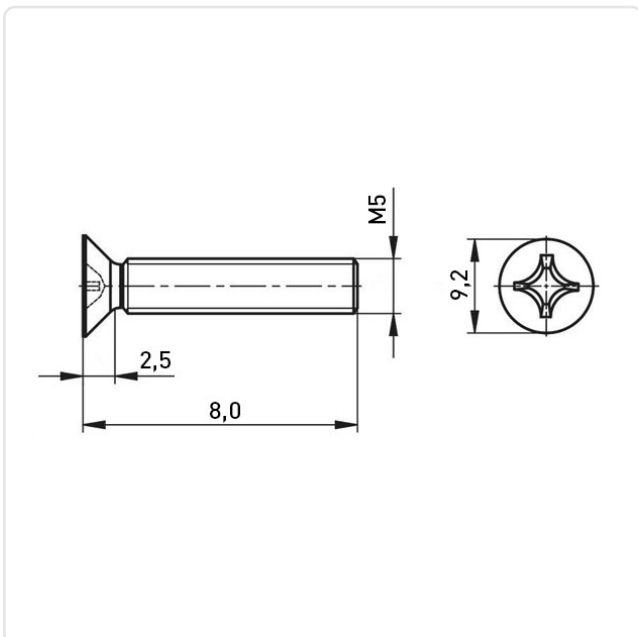

You can find all
information on the web on
our article detail page

Would you like individual advice?

We look forward to your email to products@ettinger.de.

Subject to change and errors.