

Article datasheet

Swage Standoff $\text{\O}4.2 \times 4.0$ Tin-Plated Steel

Article-No.: 004.61.815



Image may be similar

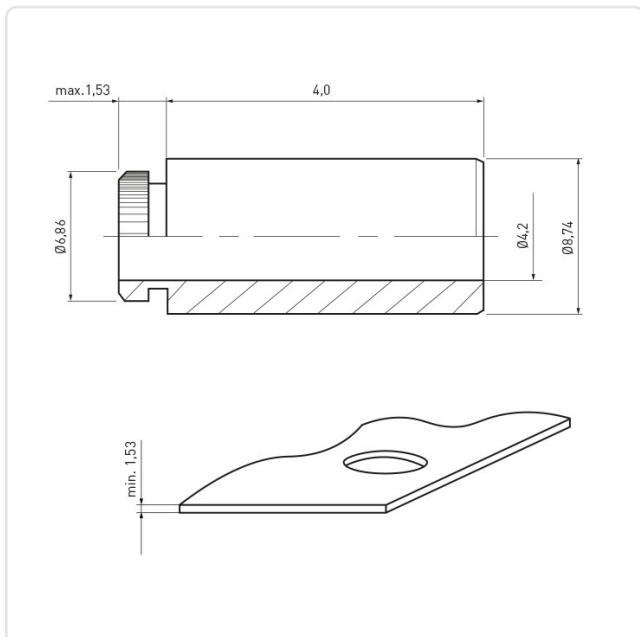

Area of Application:	For Plastics
Finish:	Tin-Plated
Inner Diameter [mm]:	4.2
Length [mm]:	4
Material:	Steel
Material Group:	Steel
Minimum Edge Distance [mm]:	7.1
Outer Diameter [mm]:	8.7
Panel Hole \O [mm]:	6.4
Panel Thickness [mm]:	1,5
Weight:	1.66g
Conformities:	



You can find all information on the web on our article detail page

Would you like individual advice?

We look forward to your email to products@ettinger.de.

Subject to change and errors.