

Article datasheet

## PCB Support 5.0 w/ Grounding Connection Polyamide 6.6 natural

Article-No.: 006.97.050

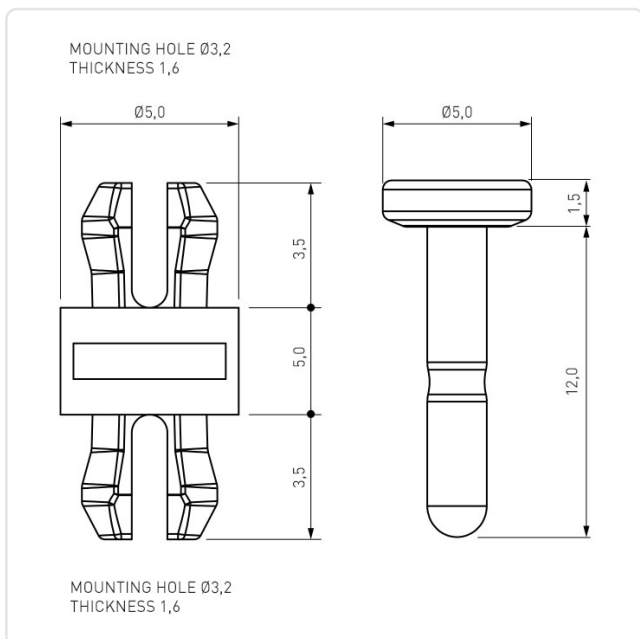

Image may be similar

Color: Natural  
Flammability Class: UL94-V2  
Length [mm]: 5  
Material: PA 6.6  
PCB Hole Ø [mm]: 3.2  
PCB Thickness [mm]: 1,6  
Panel Hole Ø [mm]: 3.2  
Panel Thickness [mm]: 1,6  
Conformities:



You can find all information on the web on our article detail page



Would you like individual advice?

We look forward to your email to [products@ettinger.de](mailto:products@ettinger.de).

Subject to change and errors.