

Article datasheet

Standoff Galvanized Steel M/M AF7x2 T1=M4x6 T2=M4x7 w/ UC

Article-No.: 005.21.421

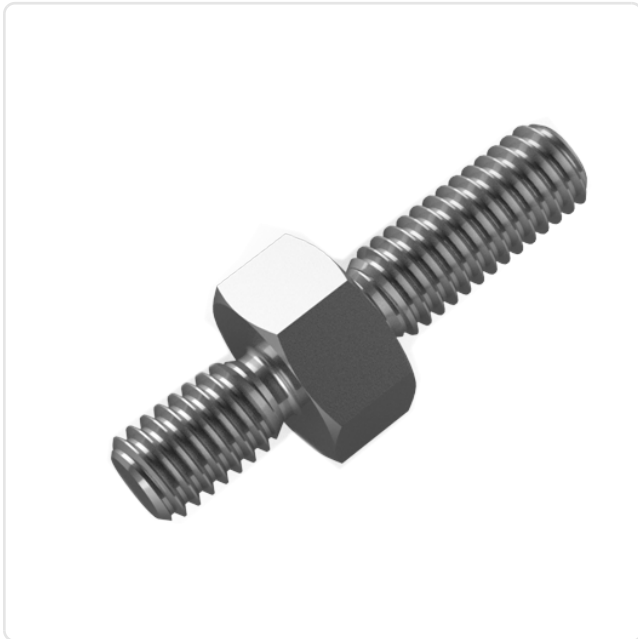
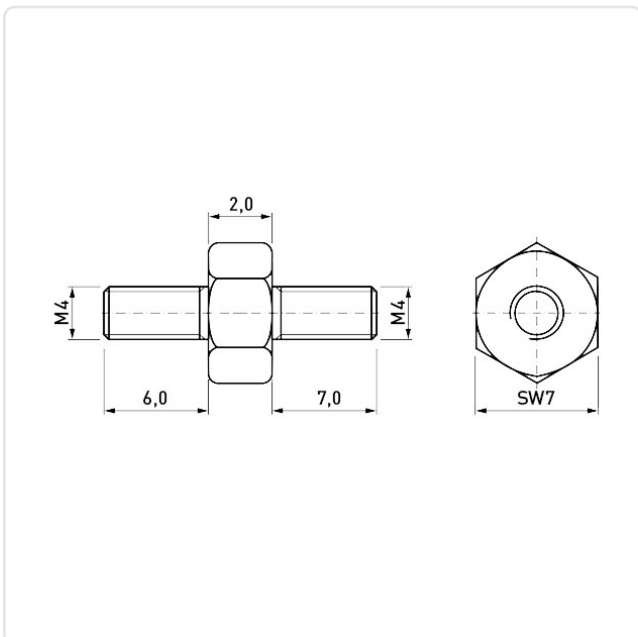

Image may be similar

AF / OD [mm]:	7
Finish:	Galvanized, Blue, 5 µm, A2K
Length [mm]:	2
Material:	Steel AISI 12L13 / 11SMnPb30
Material Group:	Steel
Profile:	Hexagonal
Thread 1 Length [mm]:	6
Thread 1 Size:	M4
Thread 2 Length [mm]:	7
Thread 2 Size:	M4
Undercut:	Yes
Weight:	1.5g
Conformities:	



You can find all
information on the web on
our article detail page

Would you like individual advice?

We look forward to your email to products@ettinger.de.

Subject to change and errors.