

Article datasheet

Fan Guards Wire Form 1/4" Ring Spacing

Article-No.: 059.64.250

Manufacturer: Qualtek

Manufacturer article-no.: 08132-02

Qualtek

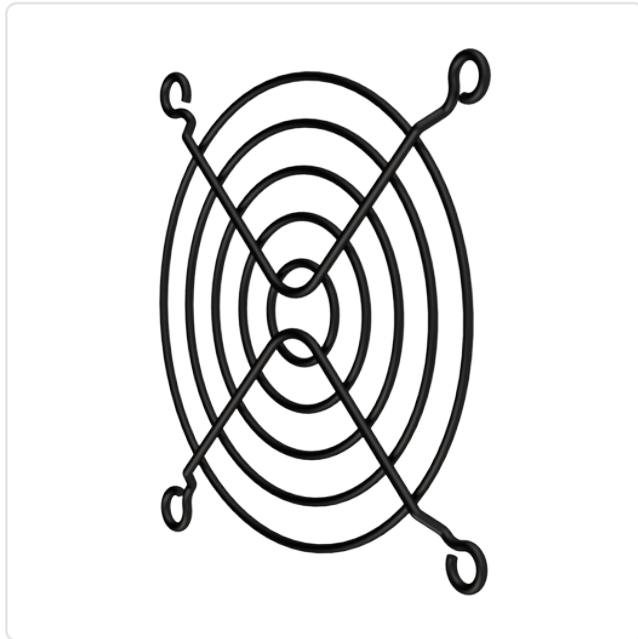

Image may be similar

Finish: Galvanized, Black, 5 µm, A2R

Lüftergröße [mm]: 80

Material: Steel

Material Group: Steel

Model: Fan Guard

Weight: 16.3g

Conformities:



You can find all information on the web on our article detail page

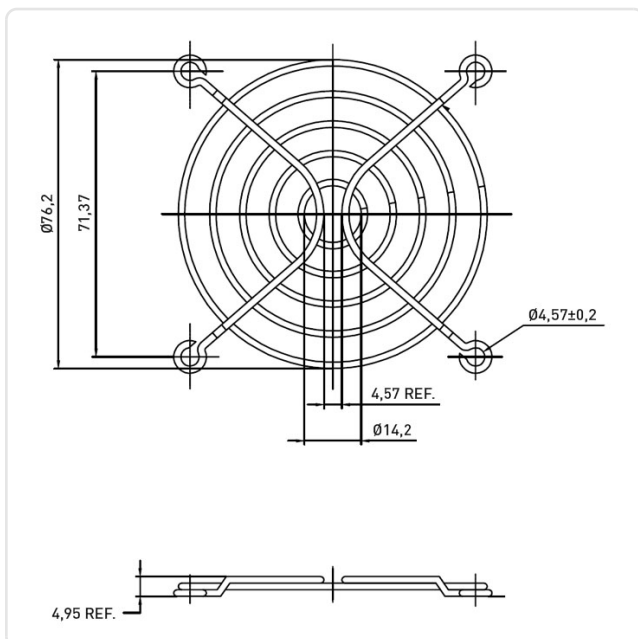

Would you like individual advice?

We look forward to your email to products@ettinger.de.

Subject to change and errors.