

Article datasheet

## Countersunk Screw ISO2009 M2x8 PA-66 Natural UL94-V2 Slotted

Article-No.: 001.46.136



Color:	Natural
DIN/ISO:	DIN963 / ISO2009
Drive Type:	Slotted
Flammability Class:	UL94-V2
Head Diameter [mm]:	3.8
Head Height [mm]:	1.2
Head Shape:	Countersunk Head
Length [mm]:	8
Material:	PA 6.6
Material Group:	Plastic
Thread Size:	M2
Weight:	0.03g
Conformities:	



Image may be similar

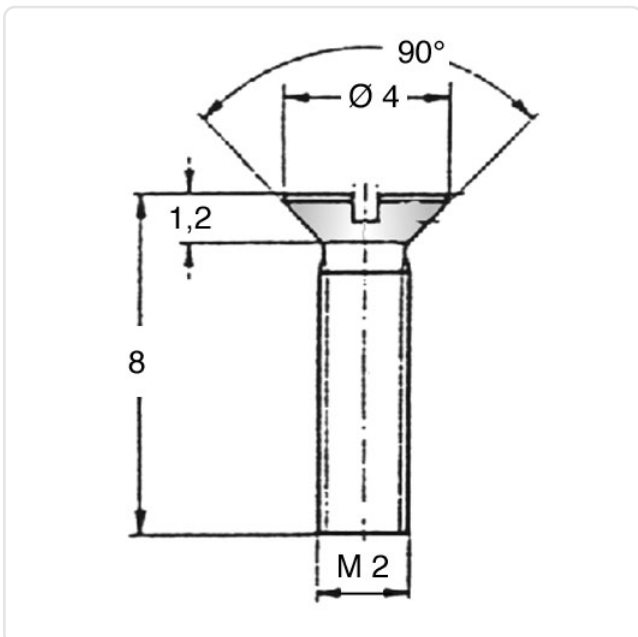

You can find all information on the web on our article detail page

Would you like individual advice?

We look forward to your email to [products@ettinger.de](mailto:products@ettinger.de).

Subject to change and errors.