

Article datasheet

Dowel Pin ISO2338 Ø4x28 A1 Plain Stainless Steel

Article-No.: 080.10.0428

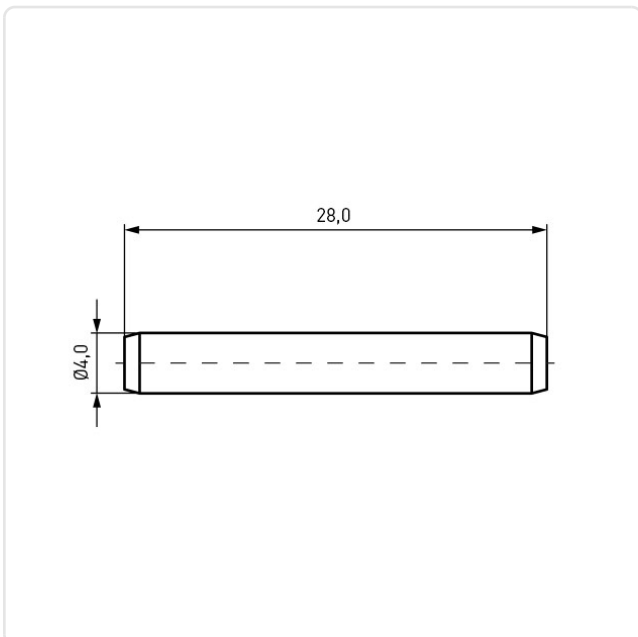

Image may be similar

DIN/ISO: DIN7 / ISO2338
Diameter [mm]: 4
Finish: Plain
Length [mm]: 28
Material: Stainless Steel A1 / AISI 303
Material Group: Stainless Steel
Weight: 2.94g
Conformities:



You can find all
information on the web on
our article detail page



Would you like individual advice?

We look forward to your email to products@ettinger.de.

Subject to change and errors.