

Article datasheet

Flat Head Screw ISO1580 M8x20 Polyamide 6.6 natural slotted Pan Head

Article-No.: 001.45.7030

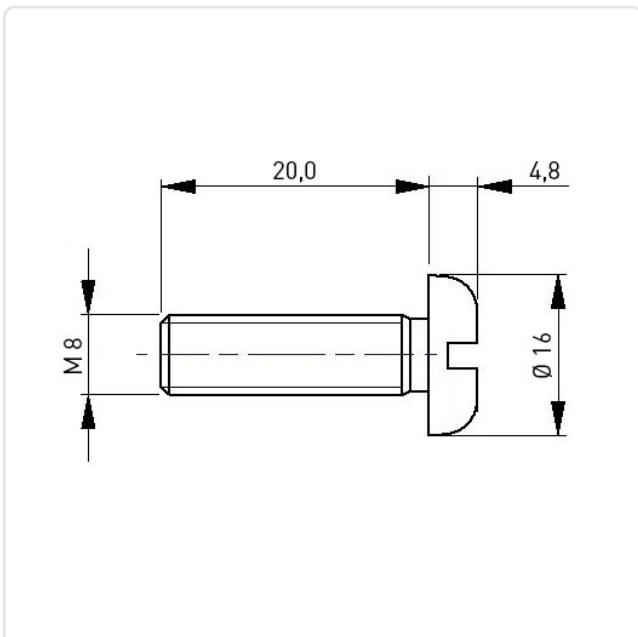

Image may be similar

Color:	Natural
DIN/ISO:	DIN85 / ISO1580
Drive Type:	Slotted
Head Diameter [mm]:	16
Head Height [mm]:	4.8
Head Shape:	Pan Head
Length [mm]:	20
Material:	PA 6.6
Thread Size:	M8
Weight:	1.706g
Conformities:	



You can find all
information on the web on
our article detail page



Would you like individual advice?

We look forward to your email to products@ettinger.de.

Subject to change and errors.