

Article datasheet

PCB Support 6.4 | $\varnothing 4.8$ | $\varnothing 3.3$ Polyamide 6.6 natural

Article-No.: 006.79.206

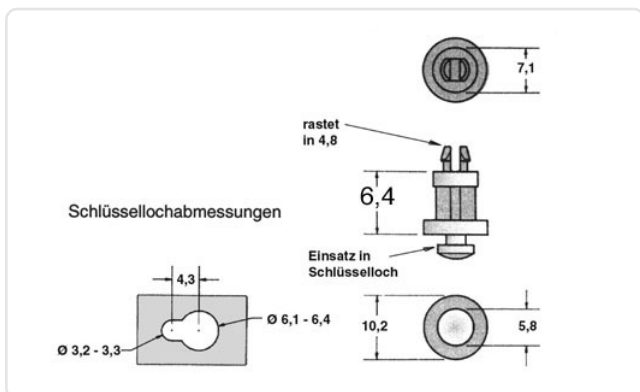

Image may be similar

Color:	Natural
Flammability Class:	UL94-V2
Length [mm]:	6.4
Material:	PA 6.6 UL94 V-2 E 70062 / RMS01
PCB Hole \varnothing [mm]:	4.8
PCB Thickness [mm]:	1,6
Panel Hole \varnothing [mm]:	6.4
Panel Thickness [mm]:	1,6
Weight:	0.37g
Conformities:	



You can find all information on the web on our article detail page



Would you like individual advice?

We look forward to your email to products@ettinger.de.

Subject to change and errors.