

Article datasheet

Flat Head Screw ISO7380-1 M2x4 Galvanized Steel 8.8 Torx Button Head

Article-No.: 001.53.101

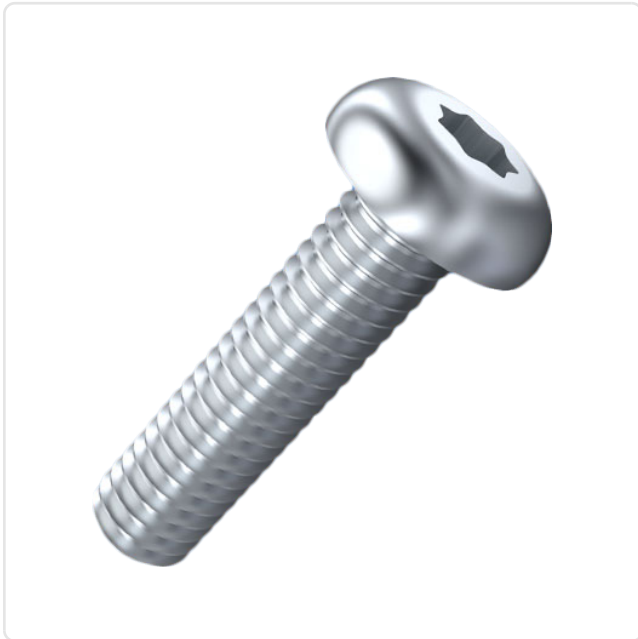
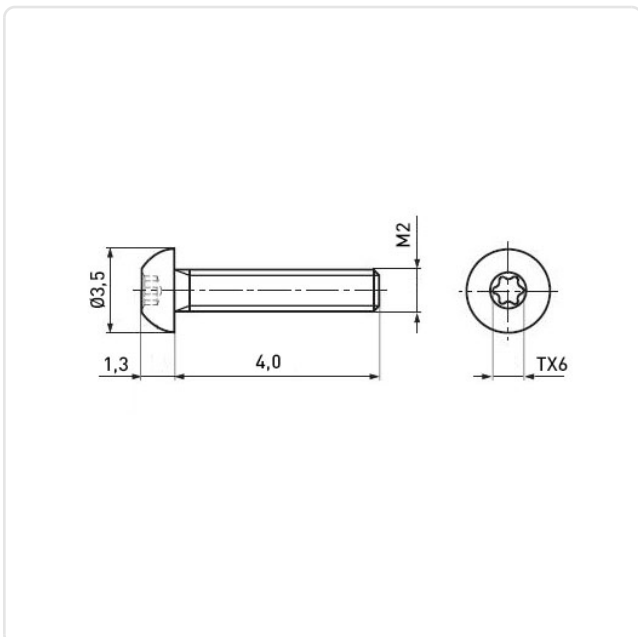

Image may be similar

Actuator Size:	Torx T6
DIN/ISO:	ISO7380-1
Drive Type:	TORX
Finish:	Galvanized, Blue, 5 µm, A2K
Head Diameter [mm]:	3.5
Head Height [mm]:	1.3
Head Shape:	Button Head
Length [mm]:	4
Material:	Steel 8.8
Material Group:	Steel
Thread Size:	M2
Weight:	0.16g
Conformities:	



You can find all
information on the web on
our article detail page

Would you like individual advice?

We look forward to your email to products@ettinger.de.

Subject to change and errors.