

Article datasheet

Insulated Standoff PBS-Steel M/F AF9x40 | F=M4x7 M=M4x7

Article-No.: 005.35.440



Image may be similar

AF / OD [mm]:	9
Female Thread Length [mm]:	7
Female Thread Size:	M4
Flammability Class:	UL94-HB
Length [mm]:	40
Male Thread Length [mm]:	7
Male Thread Size:	M4
Material:	PS - Polystyrene
Material Group:	Plastic
Profile:	Hexagonal
Thread Insert Material:	Steel
Weight:	5.2g
Conformities:	

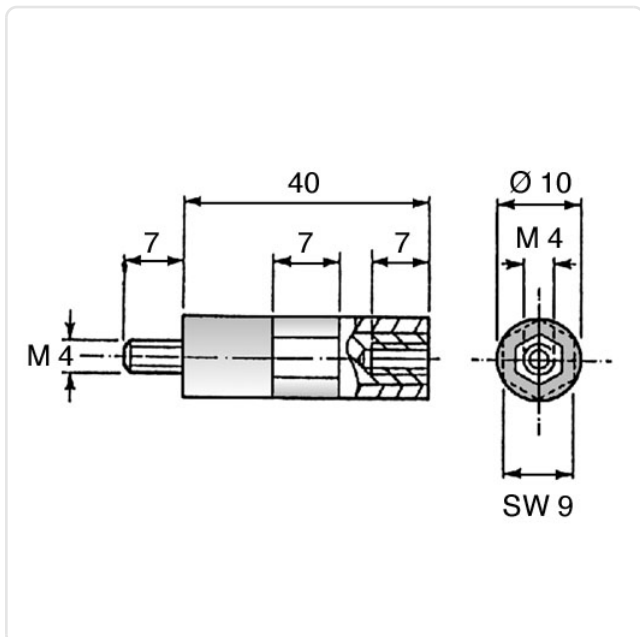

You can find all information on the web on our article detail page

Would you like individual advice?

We look forward to your email to products@ettinger.de.

Subject to change and errors.