

Article datasheet

Countersunk Screw ISO2009 M3x6 Galvanized Steel 4.8 Slotted

Article-No.: 001.11.321

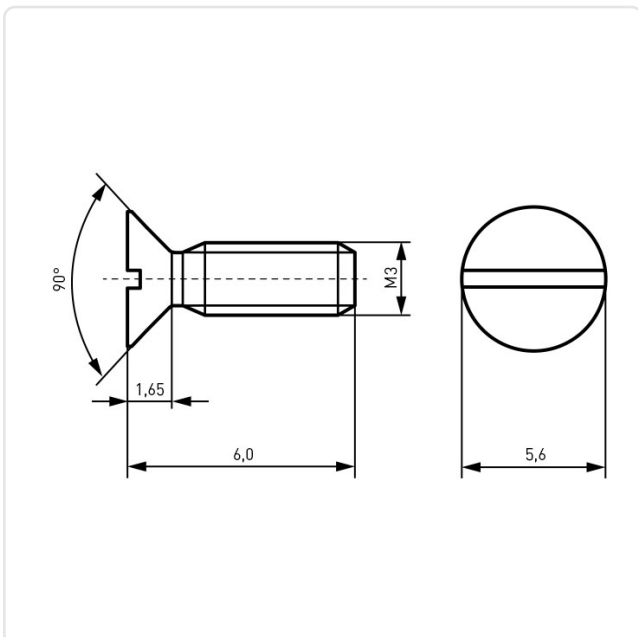

Image may be similar

DIN/ISO:	DIN963 / ISO2009
Drive Type:	Slotted
Finish:	Galvanized, Blue, 5 µm, A2K
Head Diameter [mm]:	5.6
Head Height [mm]:	1.65
Head Shape:	Countersunk Head
Length [mm]:	6
Material:	Steel 4.8
Material Group:	Steel
Thread Size:	M3
Weight:	0.35g
Conformities:	



You can find all
information on the web on
our article detail page



Would you like individual advice?

We look forward to your email to products@ettinger.de.

Subject to change and errors.