

Article datasheet

Standoff Nickel-Plated Brass M/F AF5.5x5 F=M3x2.5 M=M3x6 w/ Undercut

Article-No.: 005.13.053



AF / OD [mm]:	5.5
Female Thread Length [mm]:	2.5
Female Thread Size:	M3
Finish:	Nickel-Plated, 3 µm, E1E
Length [mm]:	5
Male Thread Length [mm]:	6
Male Thread Size:	M3
Material:	Brass CW614N / CuZn39Pb3
Material Group:	Brass
Profile:	Hexagonal
Undercut:	Yes
Weight:	1.12g
Conformities:	



Image may be similar

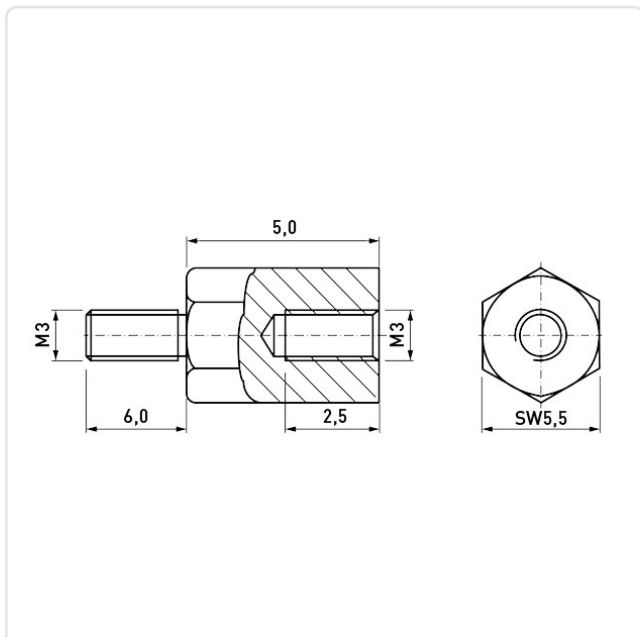

You can find all information on the web on our article detail page

Would you like individual advice?

We look forward to your email to products@ettinger.de.

Subject to change and errors.