

Article datasheet

Thread Forming Screw DIN7500M M4x12 A2 Plain Stainless Steel Torx CSK

Article-No.: 001.36.452



Image may be similar

Actuator Size:	Torx T20
DIN/ISO:	DIN7500-M
Drive Type:	TORX
Finish:	Plain
Head Diameter [mm]:	7.5
Head Height [mm]:	2.2
Head Shape:	Countersunk Head
Length [mm]:	12
Material:	Stainless Steel AISI 304 / A2
Material Group:	Stahl rostfrei
Thread Size:	M4
Thread Type:	Metric
Weight:	1.14g
Conformities:	

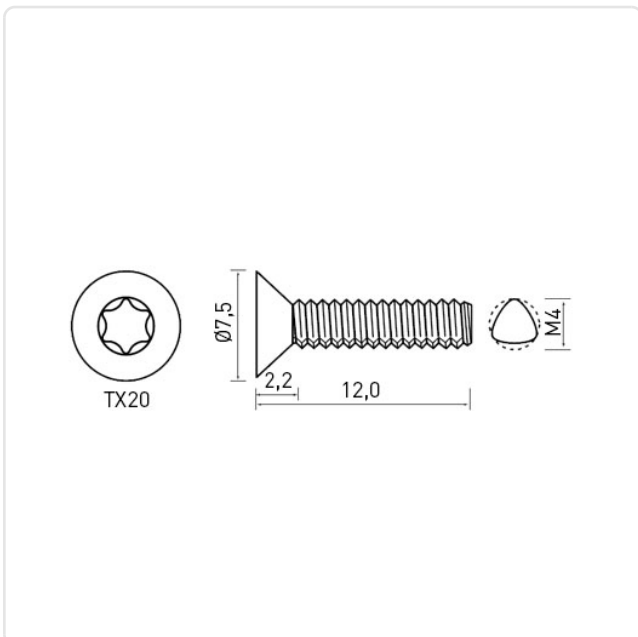

You can find all
information on the web on
our article detail page

Would you like individual advice?

We look forward to your email to products@ettinger.de.

Subject to change and errors.