

Article datasheet

Countersunk Screw ISO2009 M8x40 Polyamide 6.6 natural slotted

Article-No.: 001.46.7120

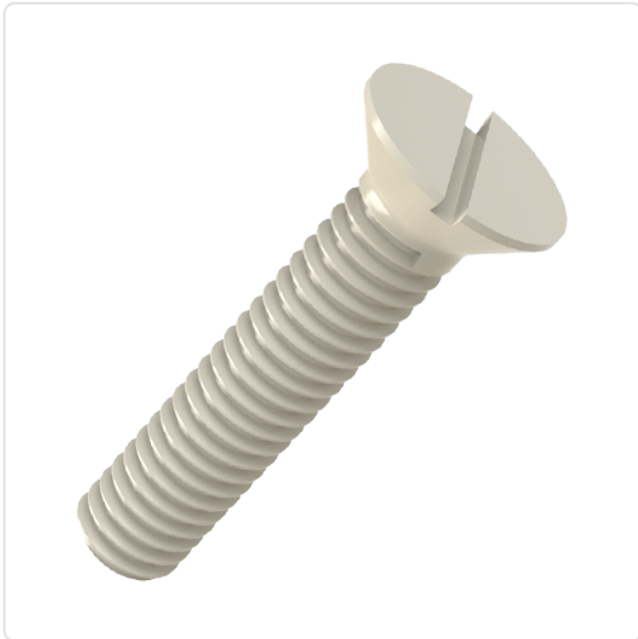
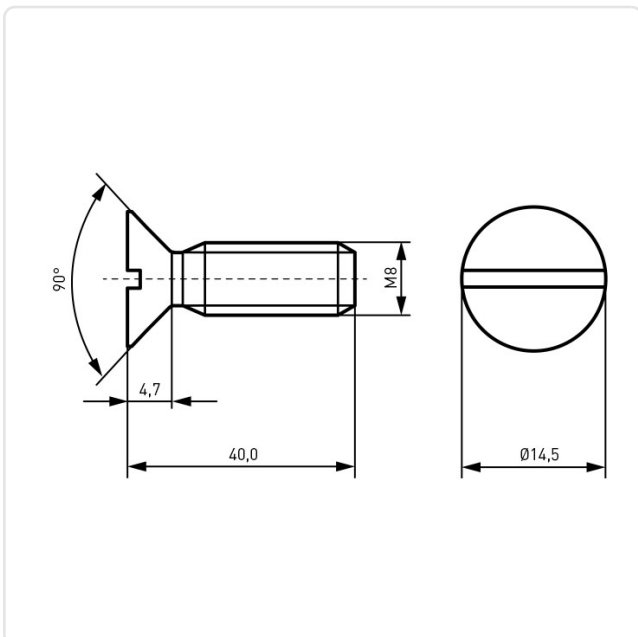

Image may be similar

Color:	Natural
DIN/ISO:	DIN963 / ISO2009
Drive Type:	Slotted
Head Diameter [mm]:	14.5
Head Height [mm]:	4.7
Head Shape:	Countersunk Head
Length [mm]:	40
Material:	PA 6.6
Thread Size:	M8
Weight:	2.106g
Conformities:	



You can find all
information on the web on
our article detail page



Would you like individual advice?

We look forward to your email to products@ettinger.de.

Subject to change and errors.