

Article datasheet

Cheese Head Screw ISO14580 M2.5x10 A2 Plain Stainless Steel Torx

Article-No.: 001.63.242



Image may be similar

Actuator Size:	Torx T8
DIN/ISO:	ISO14580
Drive Type:	TORX
Finish:	Plain
Head Diameter [mm]:	4.5
Head Height [mm]:	1.85
Head Shape:	Flat Cheese Head
Length [mm]:	10
Material:	Stainless Steel AISI 304 / A2
Material Group:	Stainless Steel
Thread Size:	M2.5
Weight:	0.4g
Conformities:	

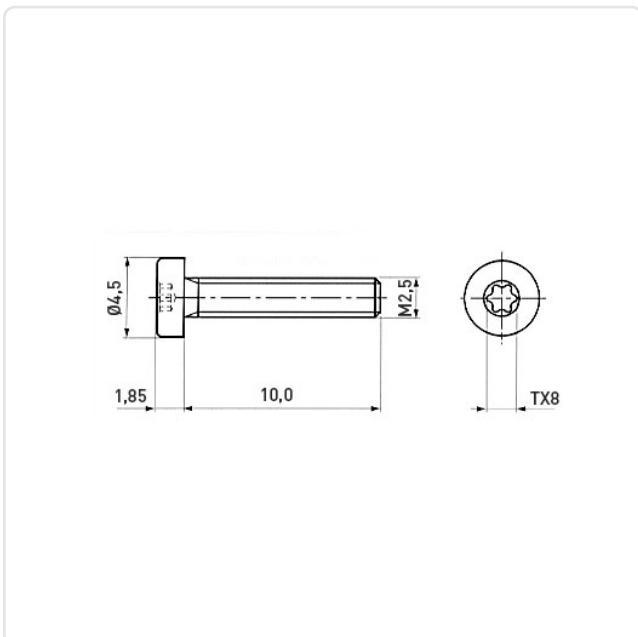

You can find all
information on the web on
our article detail page

Would you like individual advice?

We look forward to your email to products@ettinger.de.

Subject to change and errors.