

Article datasheet

## Countersunk Screw ISO7046 M2.5x8 Galvanized Steel 4.8 Cross Recessed

Article-No.: 001.12.231



Image may be similar

Actuator Size:	Phillips PH1
DIN/ISO:	DIN965 / ISO7046
Drive Type:	Cross Recess / Phillips-H
Finish:	Galvanized, Blue, 5 µm, A2K
Head Diameter [mm]:	4.7
Head Height [mm]:	1.5
Head Shape:	Countersunk Head
Length [mm]:	8
Material:	Steel 4.8
Material Group:	Stahl
Thread Size:	M2.5
Weight:	0.29g
Conformities:	

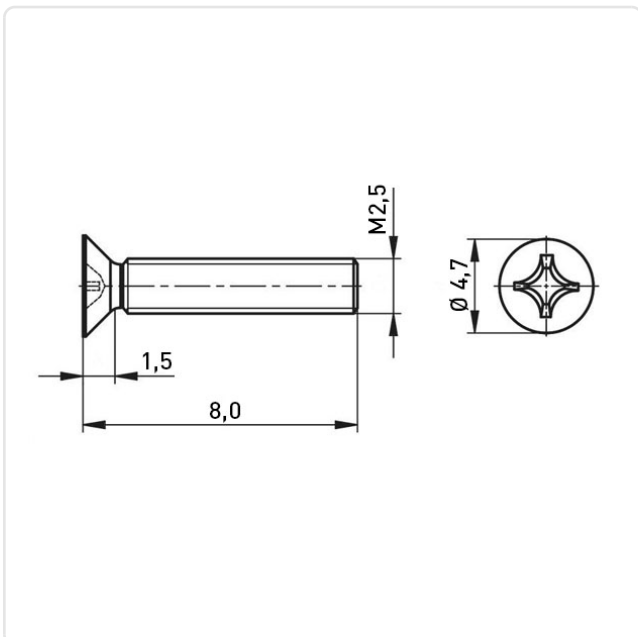

You can find all  
information on the web on  
our article detail page

Would you like individual advice?  
We look forward to your email to [products@ettinger.de](mailto:products@ettinger.de).

Subject to change and errors.