

Article datasheet

Weld Nut DIN928 M5 Plain Steel Square

Article-No.: 002.30.051

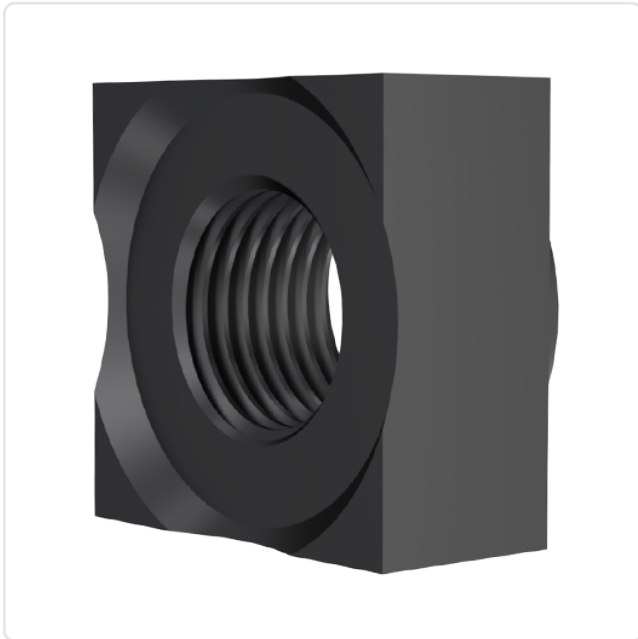
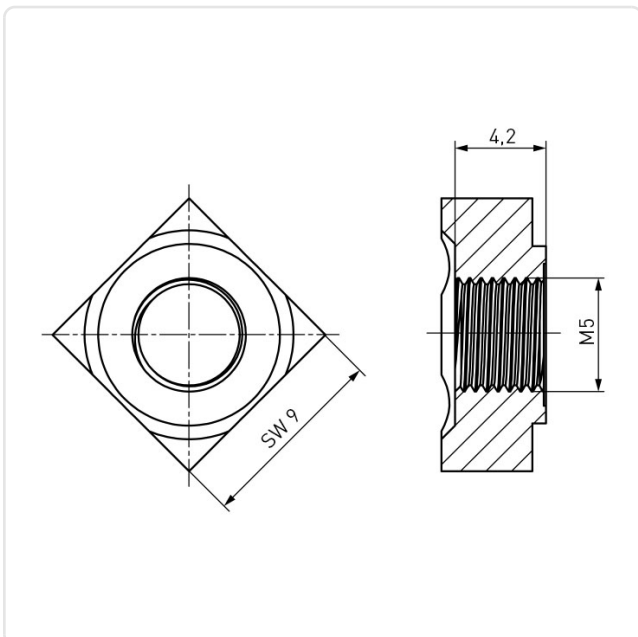

Image may be similar

AF / OD [mm]: 9
DIN/ISO: DIN928
Finish: Plain
Height [mm]: 4.2
Material: Steel
Thread Size: M5
Conformities:



You can find all
information on the web on
our article detail page



Would you like individual advice?

We look forward to your email to products@ettinger.de.

Subject to change and errors.