

Article datasheet

Flat Head Screw ISO7045 M2.5x5 PA-66 Cross Recess Pan Head

Article-No.: 001.47.216



Image may be similar

Actuator Size:	Phillips PH1
Color:	Natural
DIN/ISO:	DIN7985 / ISO7045
Drive Type:	Cross Recess / Phillips-H
Flammability Class:	UL94-V2
Head Diameter [mm]:	5
Head Height [mm]:	2
Head Shape:	Pan Head
Length [mm]:	5
Material:	PA 6.6
Material Group:	Plastic
Thread Size:	M2.5
Weight:	0.05g
Conformities:	

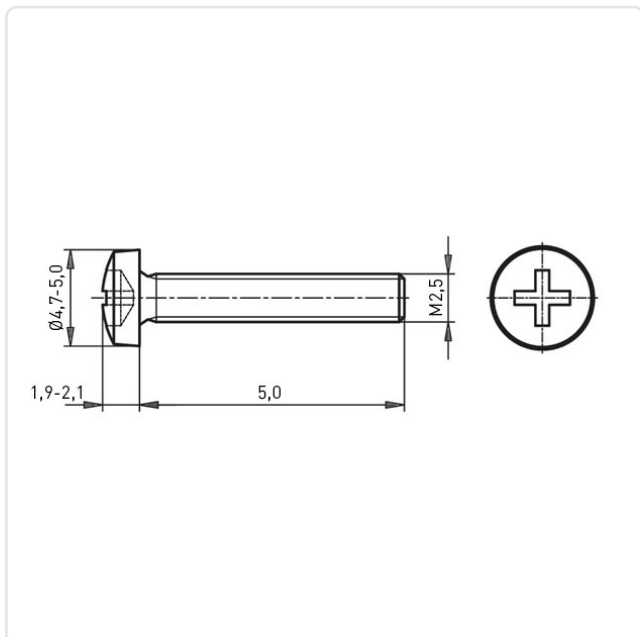

You can find all
information on the web on
our article detail page

Would you like individual advice?

We look forward to your email to products@ettinger.de.

Subject to change and errors.