

Article datasheet

Countersunk Screw ISO7047 M3x8 Galvanized Steel 4.8 Cross Recessed

Article-No.: 001.12.335



Image may be similar

Actuator Size:	Phillips PH1
DIN/ISO:	DIN966 / ISO7047
Drive Type:	Cross Recess / Phillips-H
Finish:	Galvanized, Blue, 5 µm, A2K
Head Diameter [mm]:	5.6
Head Height [mm]:	1.65
Head Shape:	Countersunk Head
Length [mm]:	8
Material:	Steel 4.8
Material Group:	Steel
Thread Size:	M3
Weight:	0.51g
Conformities:	

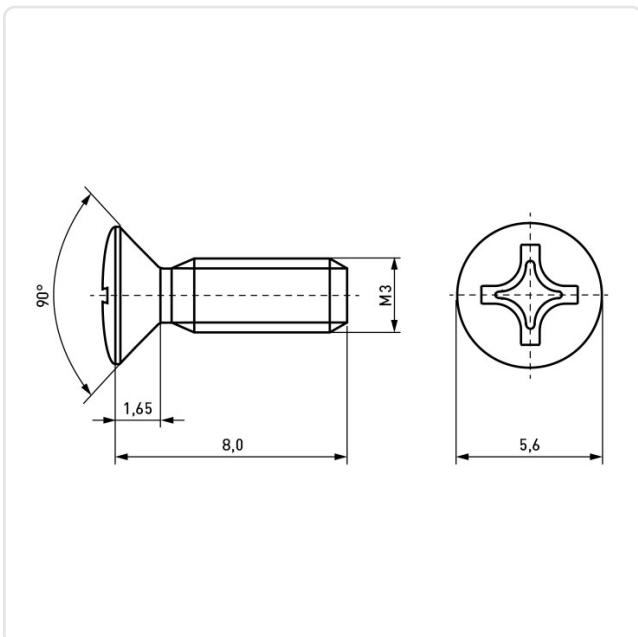

You can find all
information on the web on
our article detail page

Would you like individual advice?

We look forward to your email to products@ettinger.de.

Subject to change and errors.