

Article datasheet

## Countersunk Screw ISO7046 M6x12 Galvanized Steel 4.8 Torx

Article-No.: 001.55.651



Image may be similar

Actuator Size:	Torx T30
DIN/ISO:	DIN965 / ISO7046
Drive Type:	TORX
Finish:	Galvanized, Blue, 5 µm, A2K
Head Diameter [mm]:	11
Head Height [mm]:	3
Head Shape:	Countersunk Head
Length [mm]:	12
Material:	Steel 4.8
Material Group:	Steel
Thread Size:	M6
Weight:	2.59g
Conformities:	

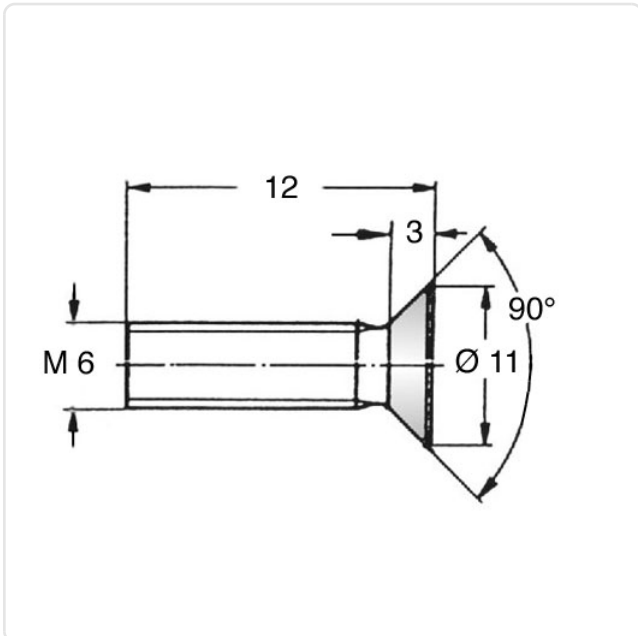

You can find all  
information on the web on  
our article detail page

Would you like individual advice?

We look forward to your email to [products@ettinger.de](mailto:products@ettinger.de).

Subject to change and errors.